

art. 342630

Istruzioni d'uso
Notice de montage
Instruction sheet
Instrucciones de empleo



INDICE

INTRODUZIONE	4
Avvertenze e consigli	4
Descrizione generale	4
Display grafico	5
Pulsanti e loro funzioni	5
Configurazione di fabbrica	6
Ripristino configurazione di fabbrica	6
IMPIEGO	7
Ricerca di un residente di cui si conosce il nome	7
Ricerca di un residente di cui si conosce il codice	8
DISPOSITIVI AGGIUNTIVI ESTERNI	9
Modulo tastiera aggiuntiva	9
Telecomando I/R	9
PROGRAMMAZIONE	10
Accesso alla programmazione	10
Pulsanti e loro funzioni	10
Menù configurazione	12
Codice segreto	13
Lingua	14
Formato rubrica	15
Centralino	16
Chiamata diretta	17
Codice porta	18
Contrasto	19
Richiamata	20
Menù rubrica	21
SOFTWARE TICALL	28
CONFIGURAZIONE	28
INSTALLAZIONE	29



Per modificare la lingua di visualizzazione dei menù:

- accedere alla modalità **Programmazione** descritta a pag. 11;
- eseguire la procedura **Lingua** descritta a pag. 14.

INTRODUZIONE

AVVERTENZE E CONSIGLI

Prima di installare il modulo è importante leggere con attenzione il presente manuale.



Il fabbricante declina ogni responsabilità per eventuali danni dovuti ad un uso errato e/o non conforme alle istruzioni contenute nel presente manuale.

DESCRIZIONE GENERALE

Il modulo fonico digitale con display grafico retroilluminato, consente di inviare la chiamata ad un posto interno scorrendo i nominativi oppure i codici dei residenti su display tramite i tasti dedicati. Il modulo può memorizzare fino a 1000 nomi e cognomi di residenti associandoli all'**indirizzo univoco di configurazione*** del PI (Posto Interno) all'interno dell'impianto. I nomi si riducono a 500 se si associa ad essi anche un messaggio. Qualora per motivi di privacy si decida di memorizzare solamente i codici dei residenti, la possibilità si estende sino a 5000 codici. È possibile associare due differenti nominativi allo stesso indirizzo MN.

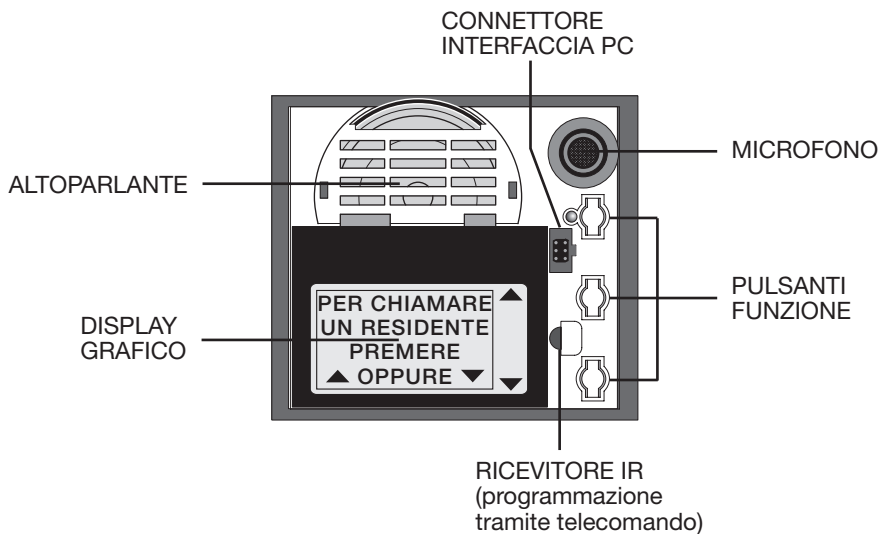

(*) All'interno del presente manuale la dicitura "**Indirizzo univoco di configurazione**" verrà in seguito riportata con la sigla **MN**.

INTRODUZIONE

DISPLAY GRAFICO

In posizione di riposo, il display del porter grafico presenta la schermata per effettuare una chiamata ad un residente.





 Quando sono abilitati lo schermo di chiamata al centralino e diretta, questi vengono mostrati in successione e ogni 10 secondi alternati allo schermo di riposo.



PULSANTI E LORO FUNZIONI

Tramite i tre pulsanti del modulo è possibile ricercare nella rubrica, visualizzata sul display, il nome o il codice del residente ed inviare la chiamata.

 • Chiama il residente selezionato

 • Scorre di una posizione precedente ▲ (pressione breve)
• Scorrimento veloce ▲ (pressione lunga 2 secondi)

 • Scorre di una posizione successiva ▼ (pressione breve)
• Scorrimento veloce ▼ (pressione lunga 2 secondi)



SCORRIMENTO VELOCE: sul display vengono visualizzati più residenti alla volta.

INTRODUZIONE

CONFIGURAZIONE DI FABBRICA

Codice segreto	1234
Lingua	Italiano
Formato rubrica	Alfanumerico senza messaggio
Centralino	4000 Disabilitato
Chiamata diretta	0000 e 0001 Disabilitato
Codice porta	1234, 1235, 1236, 1237 e 1238
Contrasto	50
Richiamata	Disabilitato

RIPRISTINO CONFIGURAZIONE DI FABBRICA

Per ripristinare la configurazione di Fabbrica:

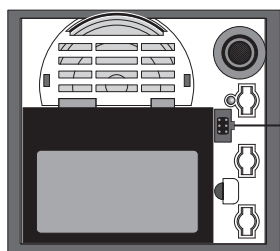

- Togliere alimentazione al dispositivo
- Inserire un jumper sui due pin inferiori dell'interfaccia

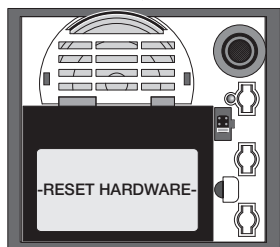

- Rialimentare il dispositivo, sul display viene visualizzato il seguente messaggio:
- RESET HARDWARE -
- Togliere alimentazione al dispositivo

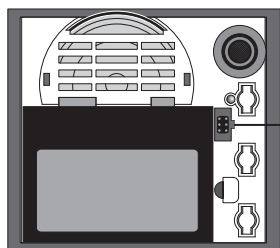

- Rimuovere il jumper
- Rialimentare il dispositivo, la configurazione di Fabbrica è ripristinata

IMPIEGO

RICERCA DI UN RESIDENTE DI CUI SI CONOSCE IL NOME

Per chiamare un residente di cui si conosce il nome:

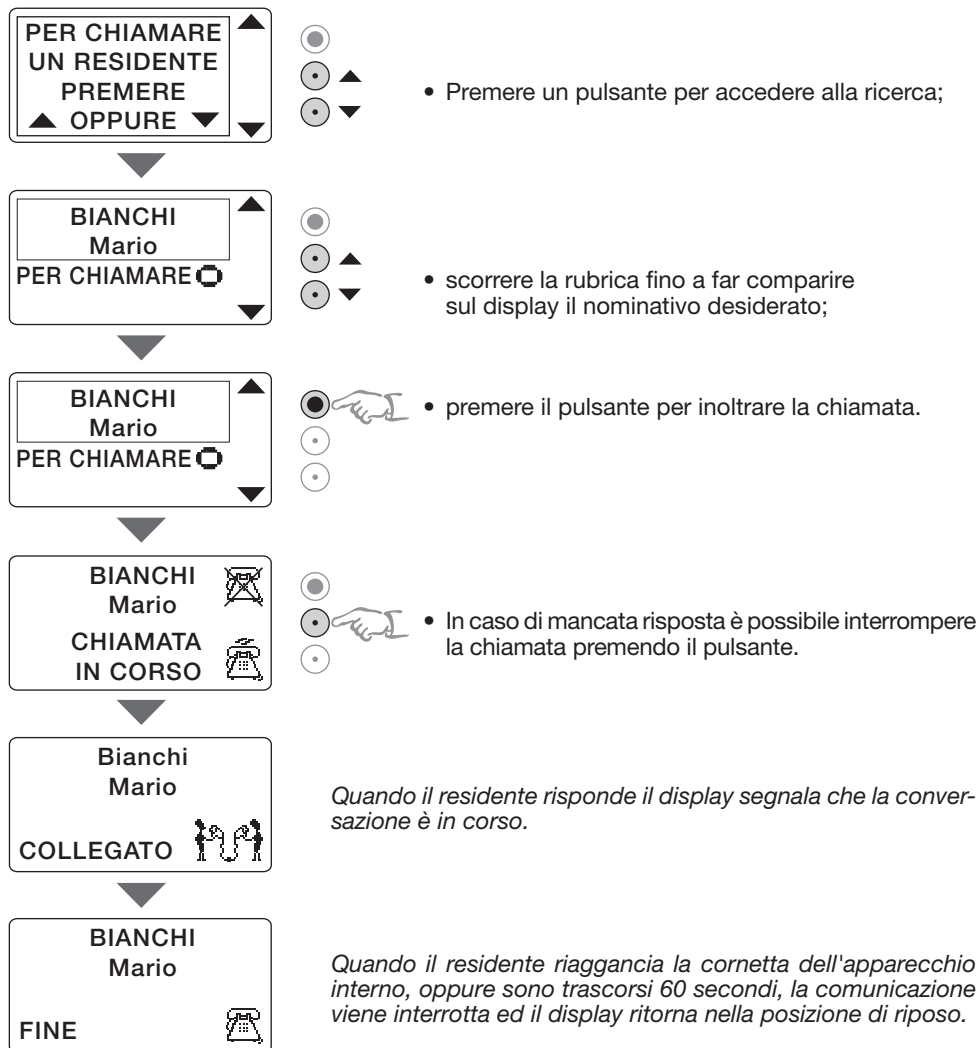

Questo tipo di ricerca è possibile solo se è stato impostato ALFANUMERICO come Formato Rubrica.

IMPIEGO

RICERCA DI UN RESIDENTE DI CUI SI CONOSCE IL CODICE

Per chiamare un residente di cui si conosce il codice:

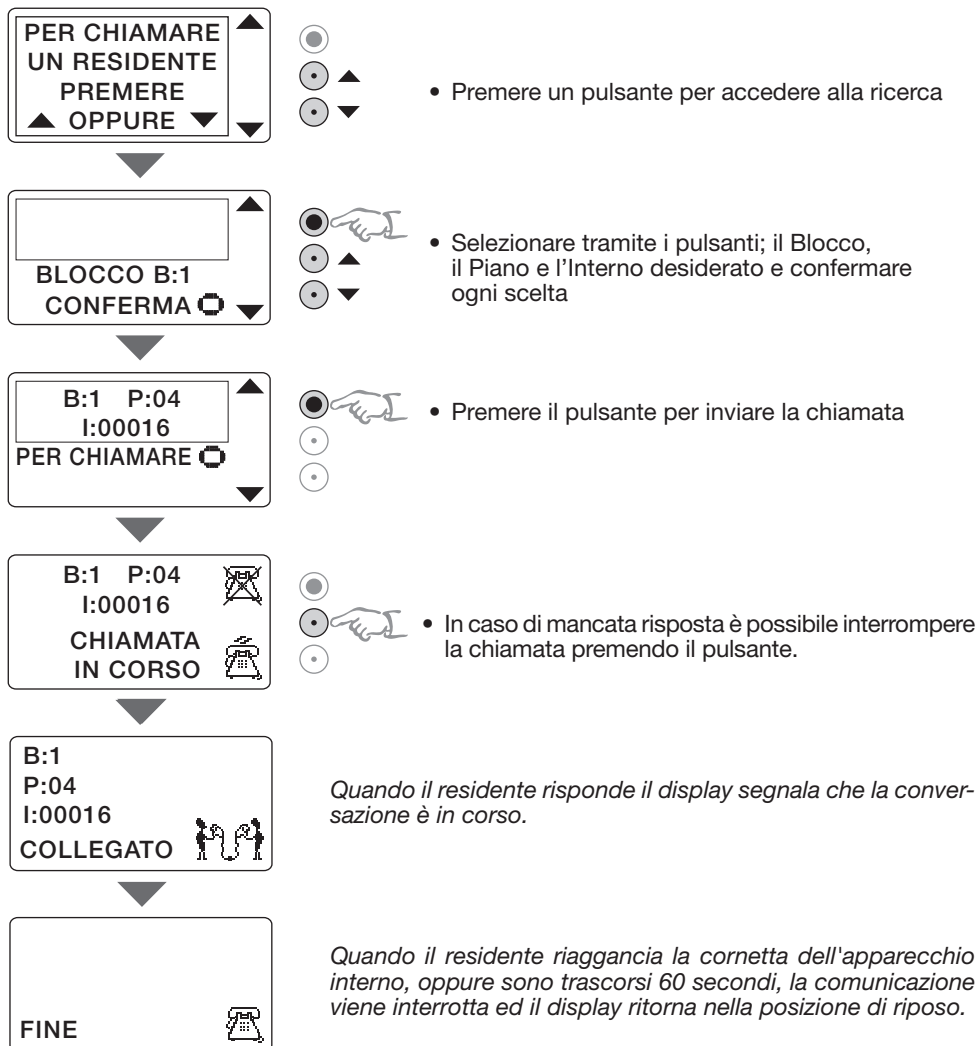

Questo tipo di ricerca è possibile solo se è stato impostato CODICE come Formato Rubrica. I codici devono essere programmati in fase di installazione, associando al residente un codice identificativo: B (blocco), P (piano) e I (interno).

DISPOSITIVI AGGIUNTIVI ESTERNI

MODULO TASTIERA AGGIUNTIVA

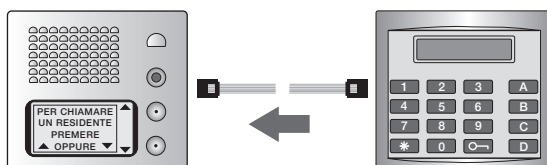

Il modulo tastiera (art. 342640) consente di:

- Chiamare direttamente il residente di cui si conosce il nome (se è stato impostato ALFANUMERICO come Formato Rubrica), componendo l'indirizzo MN sulla tastiera.
- Chiamare direttamente il residente di cui si conosce il codice (se è stato configurato CODICE come Formato Rubrica), componendo il codice (Blocco, Piano, Interno) sulla tastiera .
- Aprire la serratura, premendo il pulsante  e digitando un codice numerico.

Il modulo tastiera viene fornito con un multicavo per il collegamento al modulo fonico.

TELECOMANDO I/R



Il telecomando a raggi infrarossi (art. 392123) è utilizzabile per programmare la rubrica dei residenti.

Oltre ai tasti indicanti lettere e numeri, esistono altri tasti per particolari funzioni di programmazione:

- NEXT MESS selezione voce seguente/precedente
- SHIFT modifica la funzione di NEXT MESS e di tutti i tasti con doppio significato
- RESET esce dalla fase di editing perdendo ogni nuova impostazione
- MEMORY memorizza il nuovo dato o la nuova selezione
- BACK muove a sinistra di una posizione
- SPACE muove a destra di una posizione
- SHIFT + “. ” inserisce uno spazio (premere SHIFT poi “. ”)

PROGRAMMAZIONE

ACCESSO ALLA PROGRAMMAZIONE

L'accesso alla programmazione del Porter Grafico è protetta da Codice Segreto (di Fabbrica **1234**).

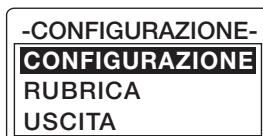

Entrati in Programmazione è possibile selezionare:

- CONFIGURAZIONE - per entrare nei menù di configurazione del dispositivo.
- RUBRICA - per entrare nel menù di configurazione della rubrica.
- USCITA - per uscire dalla programmazione e tornare alla pagina iniziale.

PULSANTI E LORO FUNZIONI

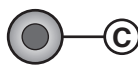
-  • Sposta a destra di una cifra il cursore (*pressione breve*)
• Conferma e memorizza (*pressione lunga 2 secondi*)

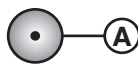
-  • Scorre di una posizione ▲ (*pressione breve*)
• Incrementa di una unità (*pressione breve*)

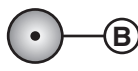
-  • Scorre di una posizione ▼ (*pressione breve*)
• Decrementa di una unità (*pressione breve*)

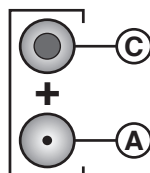
-  • I pulsanti **C + A** premuti assieme, spostano il cursore di una cifra a sinistra (*tipicamente prima C e poi A*)

PROGRAMMAZIONE

Per accedere alla programmazione:



- Mantenere premuto il pulsante per almeno 10 secondi;

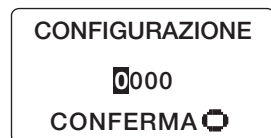

- inserire tramite i pulsanti il codice segreto (es.: 1234 codice di Fabbrica);

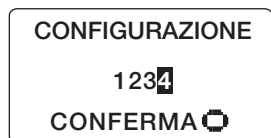

- mantenere premuto il pulsante per almeno 2 secondi per confermare.



Se il codice risulta corretto:

- si accede alla programmazione



- altrimenti si torna alla pagina iniziale

PROGRAMMAZIONE**MENÙ CONFIGURAZIONE**

In questo menù si possono configurare:

- **CODICE SEGRETO** - il codice segreto di accesso alla programmazione.
- **LINGUA** - la lingua di visualizzazione dei menù.
- **FORMATO RUBRICA** - il formato della rubrica (alfanumerico/codice).
- **CENTRALINO** - lo schermo di chiamata al centralino.
- **CHIAMATA DIRETTA** - lo schermo di chiamata diretta a due interni privilegiati.
- **CODICE PORTA** - il codice di apertura porta (max. 5 codici differenti).
- **CONTRASTO** - il valore di contrasto del display (30÷70).
- **RICHIAMATA** - il tono di richiamata automatico (ogni 10 secondi per 4 volte).

PROGRAMMAZIONE

CODICE SEGRETO

Per modificare il codice di accesso alla programmazione (di Fabbrica **1234**):

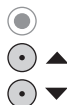
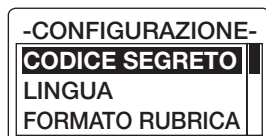

- Selezionare **Codice Segreto**;

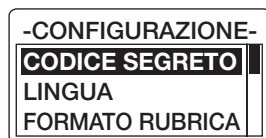

- premere il pulsante per confermare;

Sul display viene visualizzato il codice segreto in uso

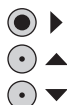

- inserire tramite i pulsanti il nuovo codice (es. 2244);

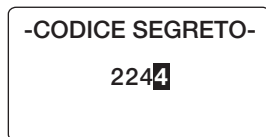

- mantenere premuto per 2 secondi il pulsante per memorizzare il nuovo codice.

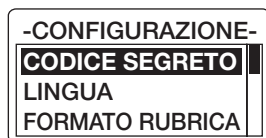

Sul display viene visualizzata la pagina iniziale



Se trascorrono più di 7 secondi, tra la pressione di un pulsante e la successiva, il display ritorna nella posizione di riposo, mantenendo impostato il vecchio codice segreto.

PROGRAMMAZIONE

LINGUA

Per modificare la lingua del dispositivo (di Fabbrica - **Italiano**):

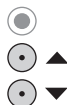
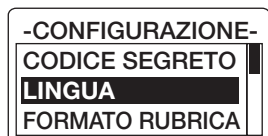

- Selezionare **Lingua**;

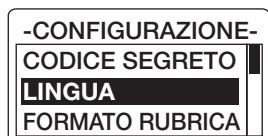

- premere il pulsante per confermare;

Sul display viene evidenziata la lingua in uso

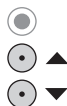

- selezionare tramite i pulsanti la lingua desiderata (es.: English);



- premere il pulsante per confermare la nuova lingua.

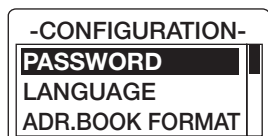

Sul display viene visualizzata la pagina iniziale nella nuova lingua impostata



È possibile sostituire la lingua "Custom" con una lingua predefinita tramite il software TiCall.

PROGRAMMAZIONE

FORMATO RUBRICA

Per modificare il formato della rubrica del dispositivo (di Fabbrica - **alfanumerico senza messaggio**):

-CONFIGURAZIONE-
 CODICE SEGRETO
 LINGUA
FORMATO RUBRICA

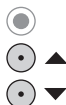

- Selezionare **Formato Rubrica**



-CONFIGURAZIONE-
 CODICE SEGRETO
 LINGUA
FORMATO RUBRICA



- Premere il pulsante per confermare



Sul display viene evidenziato il formato in uso

-FORMATO RUBRICA-
ALFANUMERICO
 CODICE



- selezionare tramite i pulsanti il nuovo formato*;



-FORMATO RUBRICA-
ALFANUMERICO
CODICE



- premere il pulsante per confermare 



EEPROM CANCEL



La modifica o la conferma del "Formato rubrica" in uso, determina la cancellazione di tutti i dati contenuti nella rubrica dei residenti.

(* Le scelte possibili sono:

ALFANUMERICO:

- **senza messaggio:** max **1000** residenti (cognome + nome)
- **con messaggio:** max **500** residenti (cognome + nome + messaggio)

CODICE: max **5000** residenti (codice)

PROGRAMMAZIONE

CENTRALINO

Per abilitare lo schermo di chiamata al centralino:

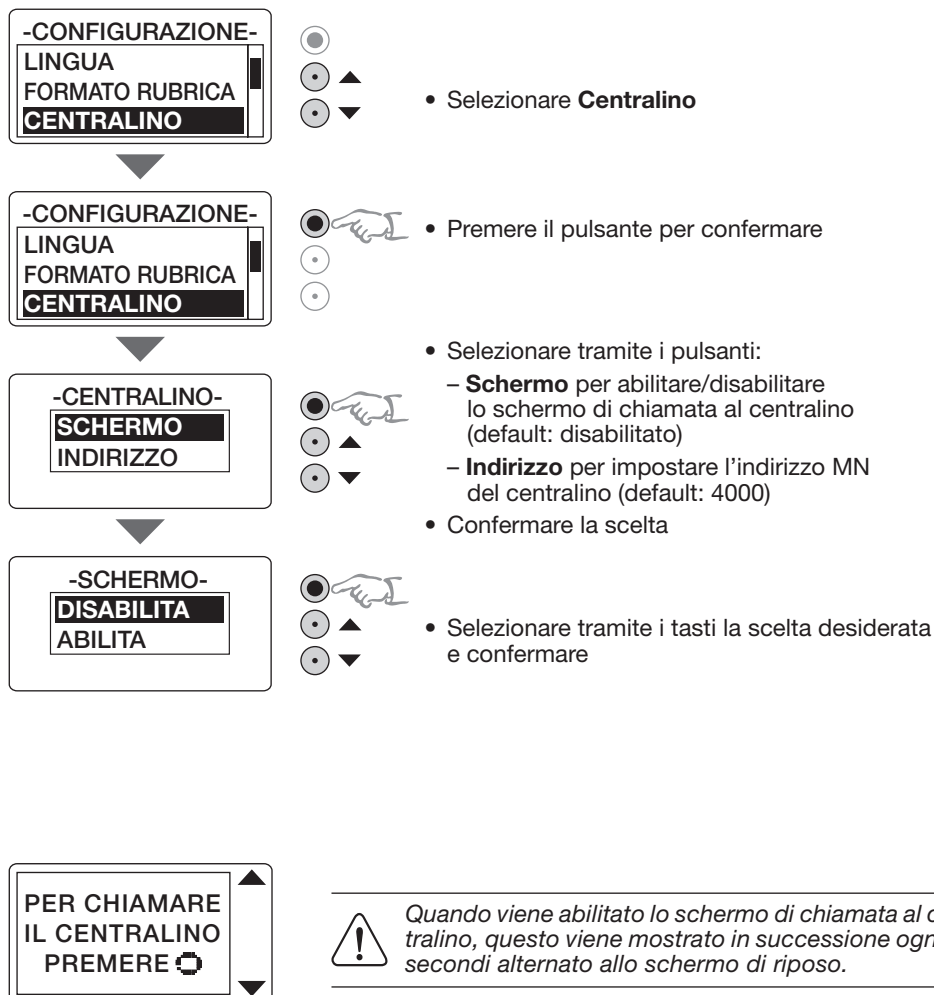

PROGRAMMAZIONE

CHIAMATA DIRETTA

Per abilitare lo schermo di chiamata diretta a due interni privilegiati:

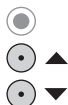
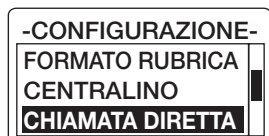

- Selezionare **Chiamata Diretta**;

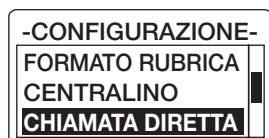

- premere il pulsante per confermare;

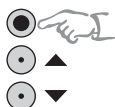

- selezionare tramite i pulsanti:
 - **Schermo** per abilitare/disabilitare lo schermo di chiamata diretta a due interni privilegiati (default: disabilitato)
 - **Indirizzo** per impostare l'indirizzo MN degli interni privilegiati (di Fabbrica: 0000 e 0001)
- confermare la scelta;

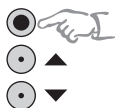
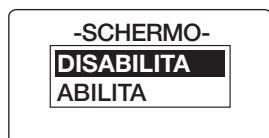

- selezionare tramite i pulsanti la scelta desiderata e confermare.

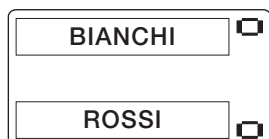

Quando viene abilitato lo schermo di chiamata diretta, questo viene mostrato in successione ogni 10 secondi alternato allo schermo di riposo.



È possibile abilitare questa funzione solo se il Formato rubrica è stato configurato come Alfanumerico.

PROGRAMMAZIONE

CODICE PORTA

Questa funzione consente di programmare fino a 5 differenti codici di apertura della porta (di Fabbrica 1234, 1235, 1236, 1237, 1238).

Per modificare il codice di apertura della porta:

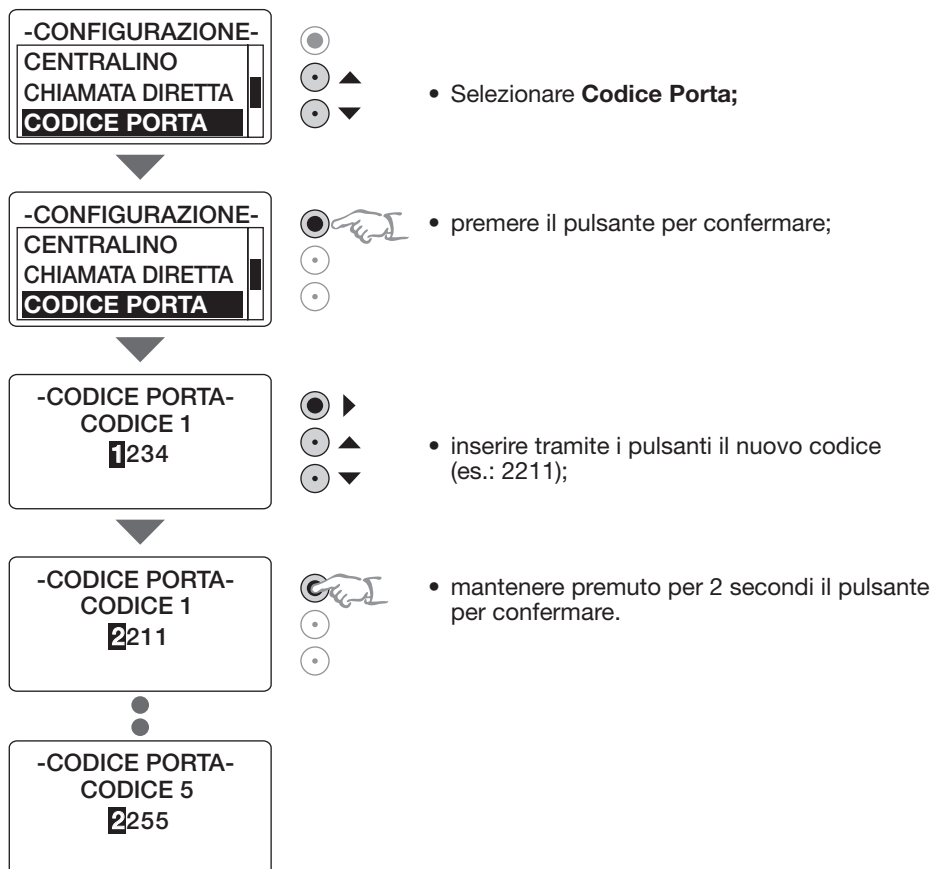

Esempio: Assegnando i **codici porta** con la seguente logica:

- CODICE 1** - residenti
- CODICE 2** - servizio di sorveglianza
- CODICE 3** - servizio di manutenzione
- CODICE 4** - postino
- CODICE 5** - servizio acqua e gas

sarà possibile modificare un codice assegnato (es.: postino) lasciando invariati gli altri.

PROGRAMMAZIONE

CONTRASTO

Per modificare il valore di contrasto del display (di Fabbrica - 70):

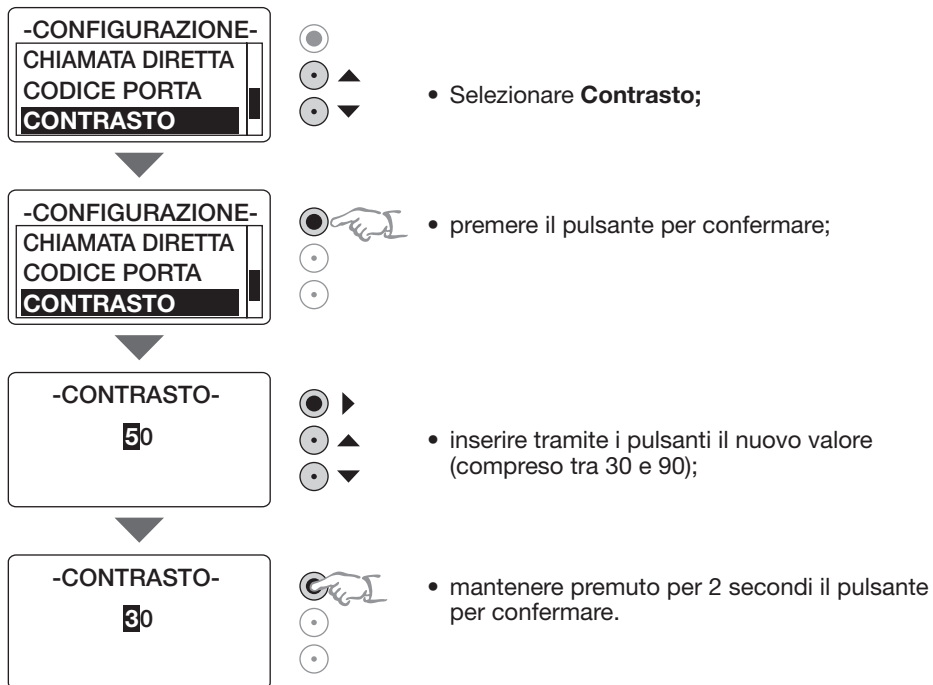

PROGRAMMAZIONE**RICHIAMATA**

Per abilitare il tono di richiamata automatico, 10 secondi per quattro volte
(di Fabbrica - **disabilitato**):

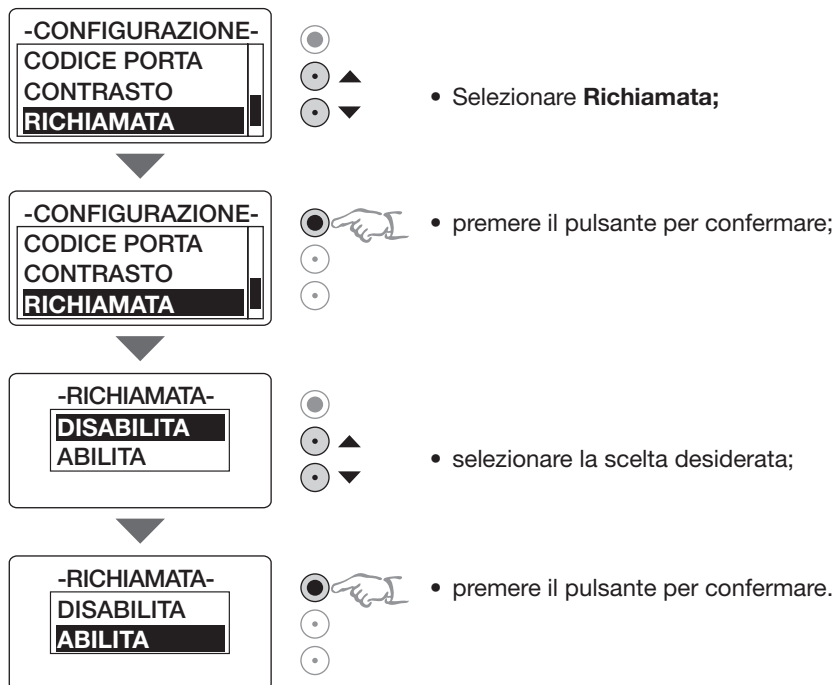

PROGRAMMAZIONE

MENÙ RUBRICA

In questo menù si possono inserire nella rubrica nuovi residenti, modificare i dati inseriti oppure cancellarli.



I menù variano in funzione del "Formato rubrica" impostato Alfanumerico o Codice.

Per accedere al menù rubrica:

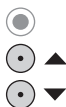

- Selezionare **Rubrica**



- Premere il pulsante per confermare

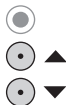

- Selezionare la funzione desiderata



PROGRAMMAZIONE

Nuovo (Alfanumerico)

Per inserire un nuovo residente nella rubrica:

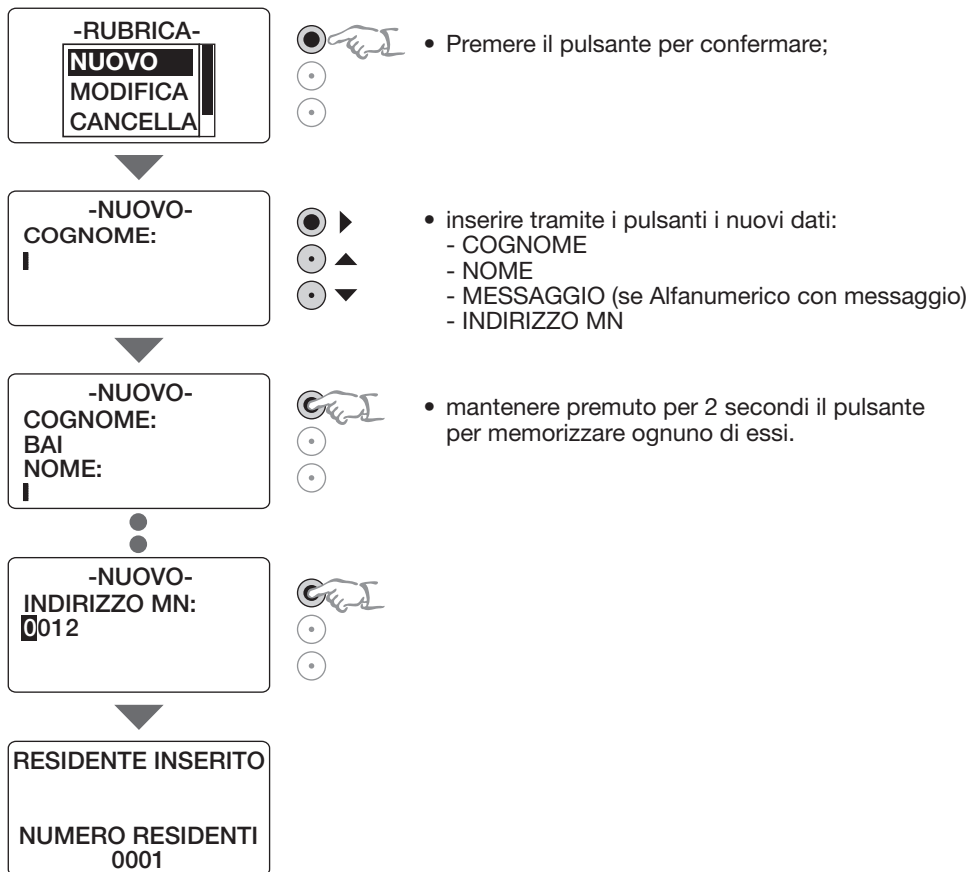

PROGRAMMAZIONE

Modifica (Alfanumerico)

Per modificare i dati di un residente presente nella rubrica:

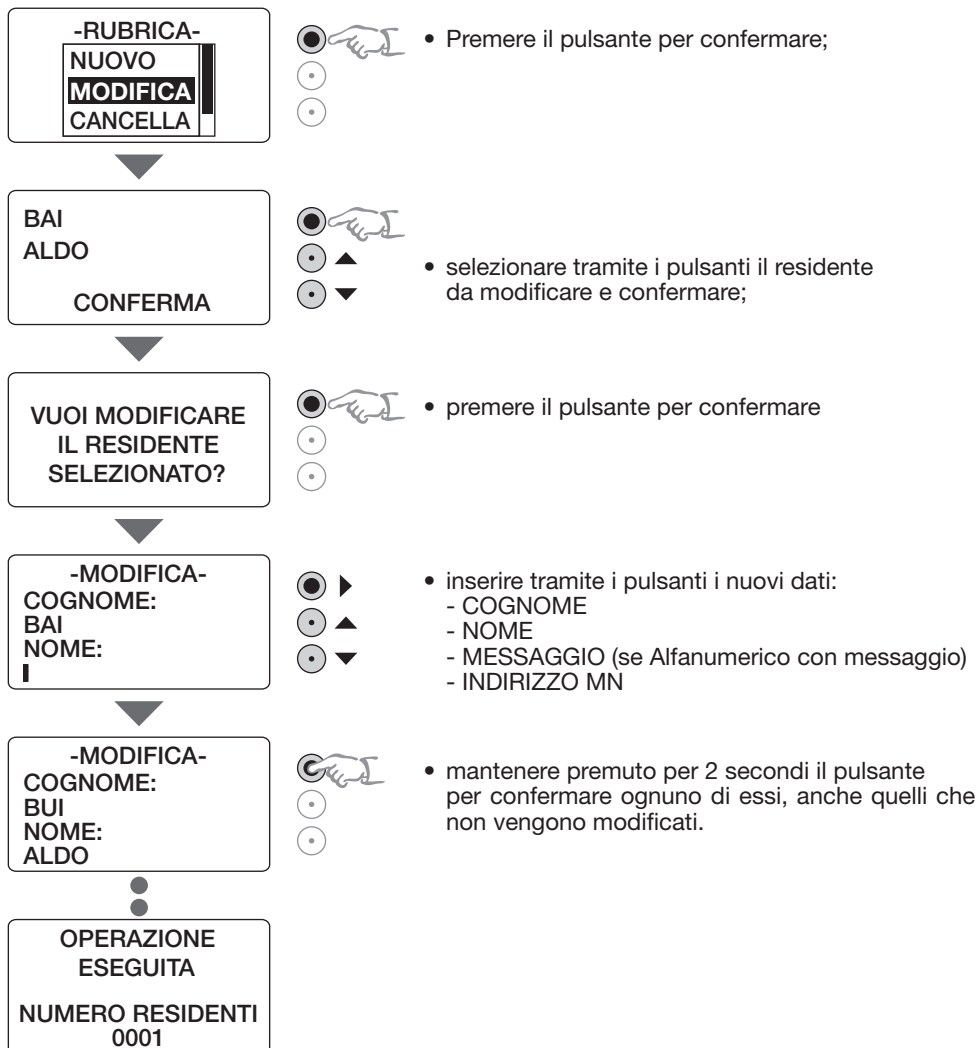

PROGRAMMAZIONE**Cancella (Alfanumerico)**

Per cancellare un residente dalla rubrica:

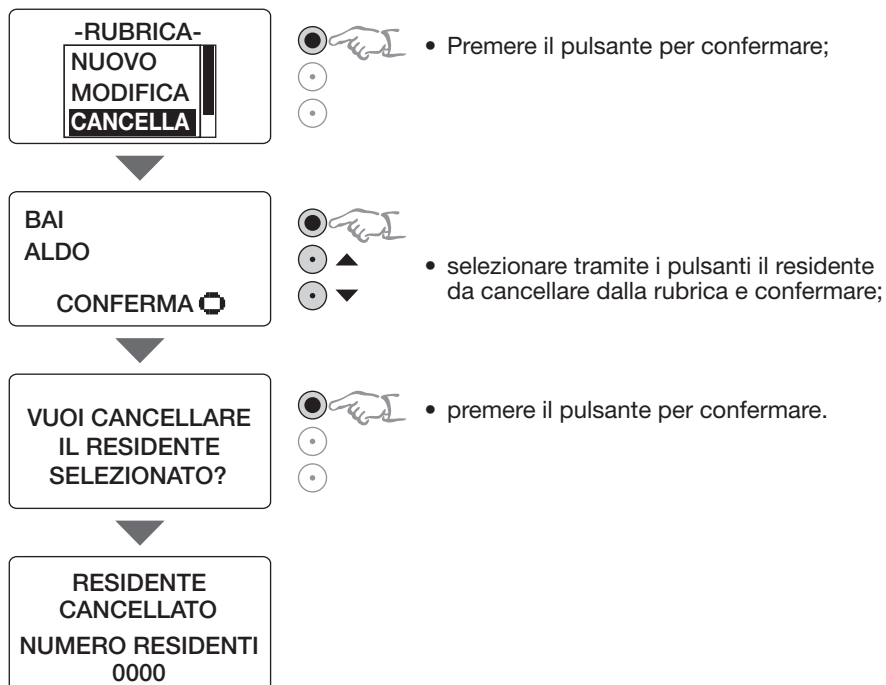

PROGRAMMAZIONE

Nuovo (Codice)

Per inserire un nuovo residente nella rubrica:

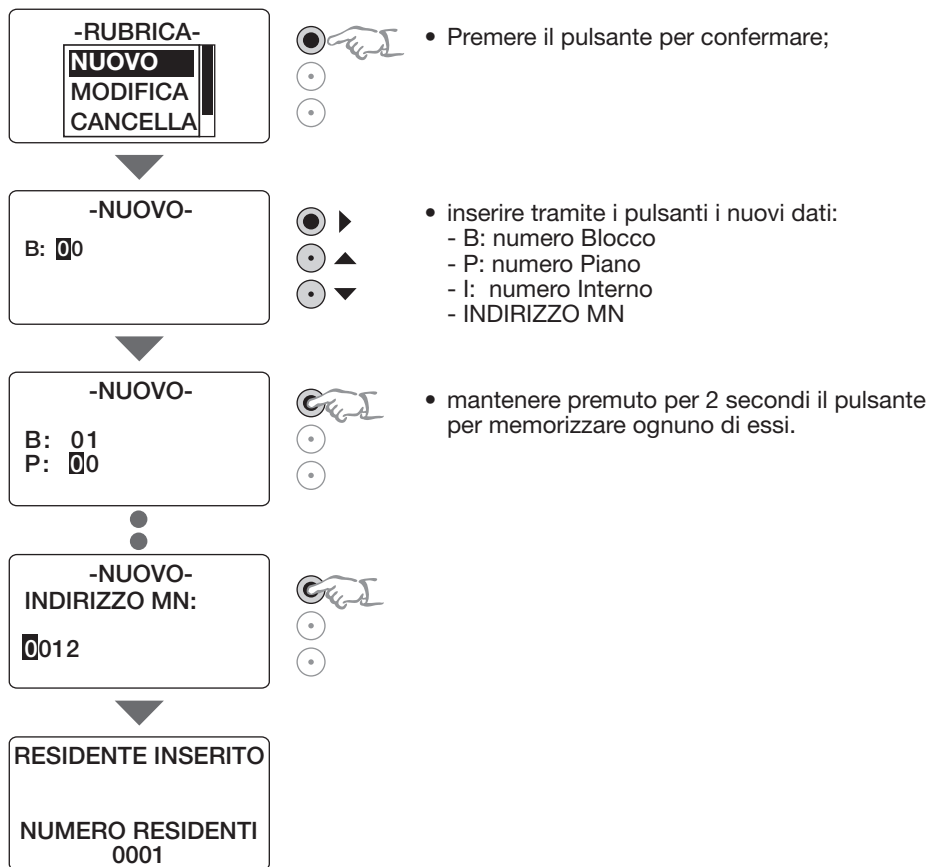

PROGRAMMAZIONE

Modifica (Codice)

Per modificare i dati di un residente presente nella rubrica:

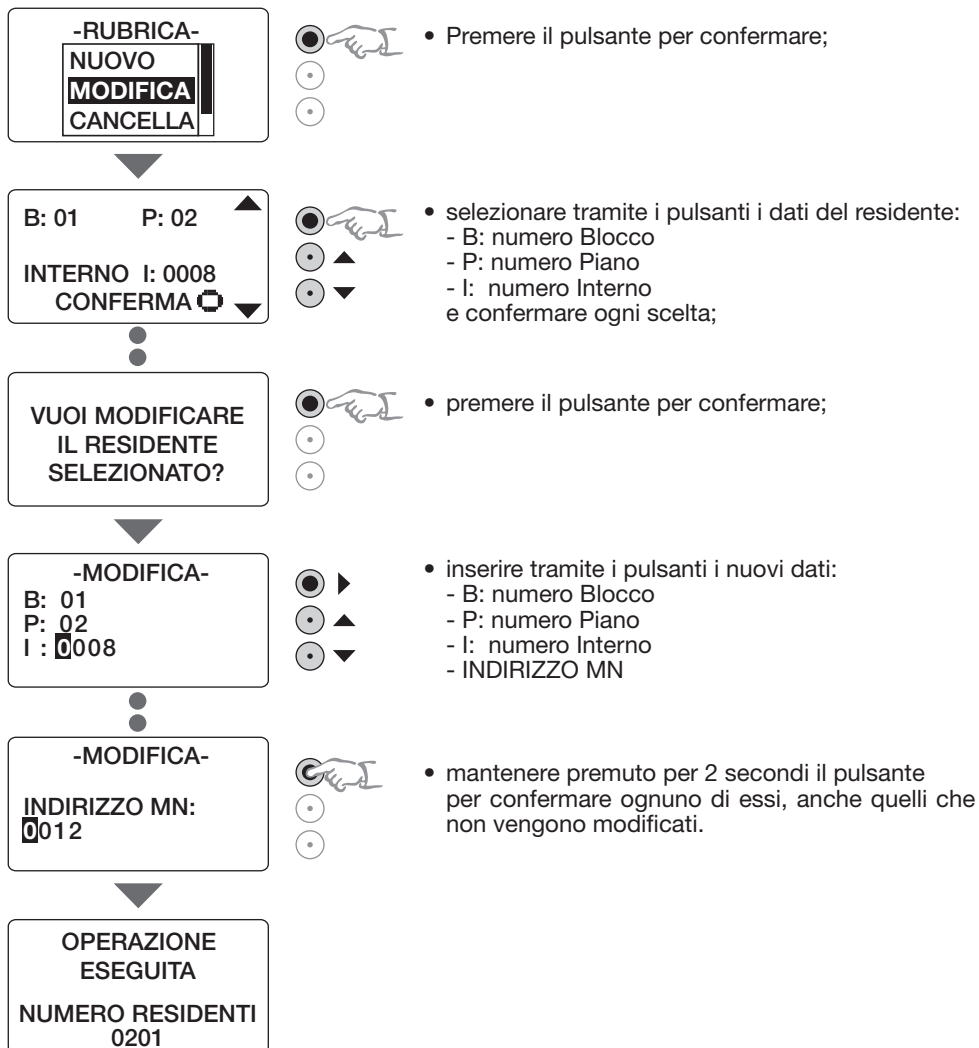

PROGRAMMAZIONE

Cancella (Codice)

Per cancellare un residente presente nella rubrica:

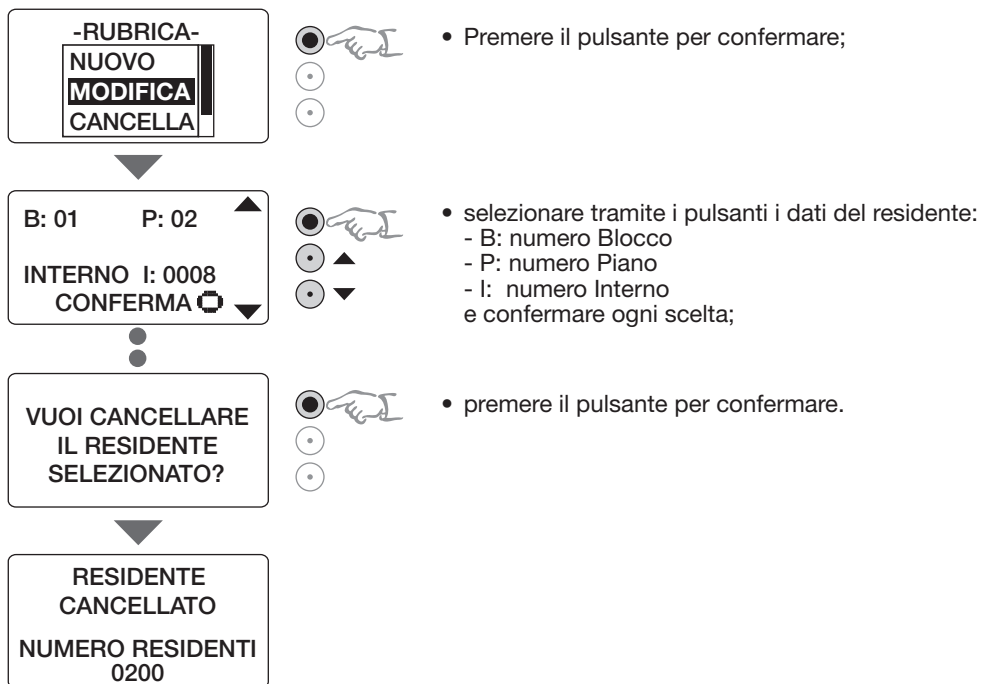

SOFTWARE TICALL

Il software TICALL permette la programmazione di tutti i parametri presenti nei menù di configurazione del dispositivo, mediante un PC con sistema operativo Microsoft.

La programmazione delle funzioni di cui sopra, può essere effettuata a dispositivo già installato tramite bus SCS, oppure precedentemente all'installazione (è sufficiente alimentare il modulo fonico), collegandolo alla porta RS232 del PC tramite il cavo di interfaccia seriale (art. 335919). Per trasferire la programmazione il display del modulo deve visualizzare la pagina iniziale (posizione di riposo).

Assegnando ad ogni programmazione personalizzata un nome, sarà possibile gestirne l'archiviazione come un qualunque file.

Il software consente inoltre di procedere all'aggiornamento firmware del dispositivo e alla sostituzione della lingua "Custom" con una lingua predefinita tramite il cavo di interfaccia seriale (art. 335919).

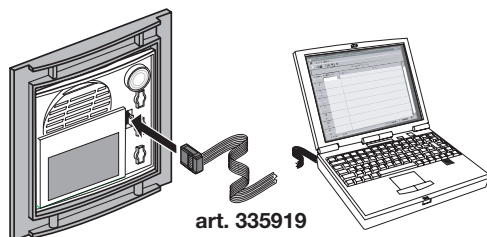

art. 335919

CONFIGURAZIONE

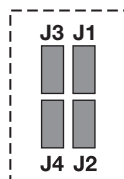
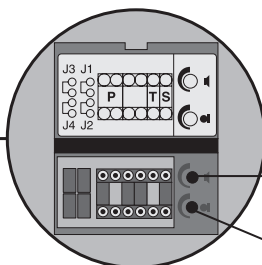
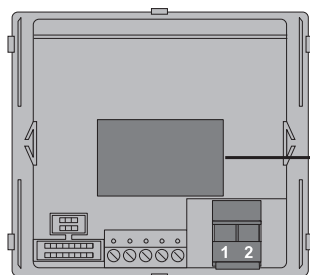

Regolazione volume altoparlante

Regolazione sensibilità del microfono

P - numero del posto esterno

Il configuratore inserito nella sede P del modulo fonico, assegna a quest'ultimo un numero di riconoscimento all'interno del sistema.

Il posto esterno principale non deve essere configurato in P, mentre tutti gli altri posti esterni devono essere numerati in modo progressivo.

T - temporizzazione relé serratura

numero del configuratore							
0= Nessun configuratore	1	2	3	4	5	6	7
4 sec.	1 sec.	2 sec.	3 sec.	come pulsante	6 sec.	8 sec.	10 sec.

S - tipo di segnale di chiamata

La configurazione di S determina il tono della chiamata dei posti interni. È così possibile differenziare le chiamate provenienti da posti esterni differenti.

Configuratore	0	1	2	3
Tipo di suoneria	Bitonale	Bitonale	Bitonale	Monotonale
	1200 Hz	1200 Hz	1200 Hz	1200 Hz
	600 Hz	0 Hz	2400 Hz	

J4 - conferma chiamata su PE

Per eliminare il tono di chiamata sul posto esterno, togliere il jumper J4.

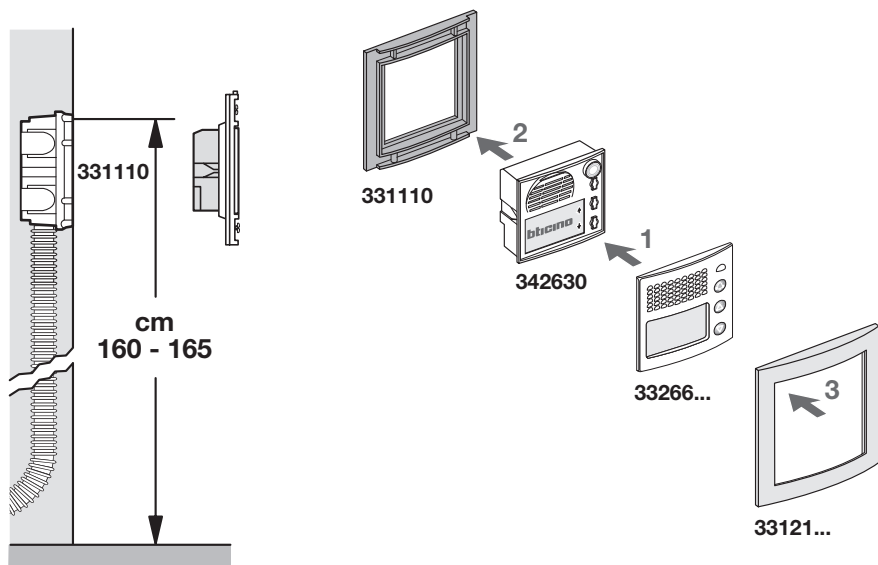
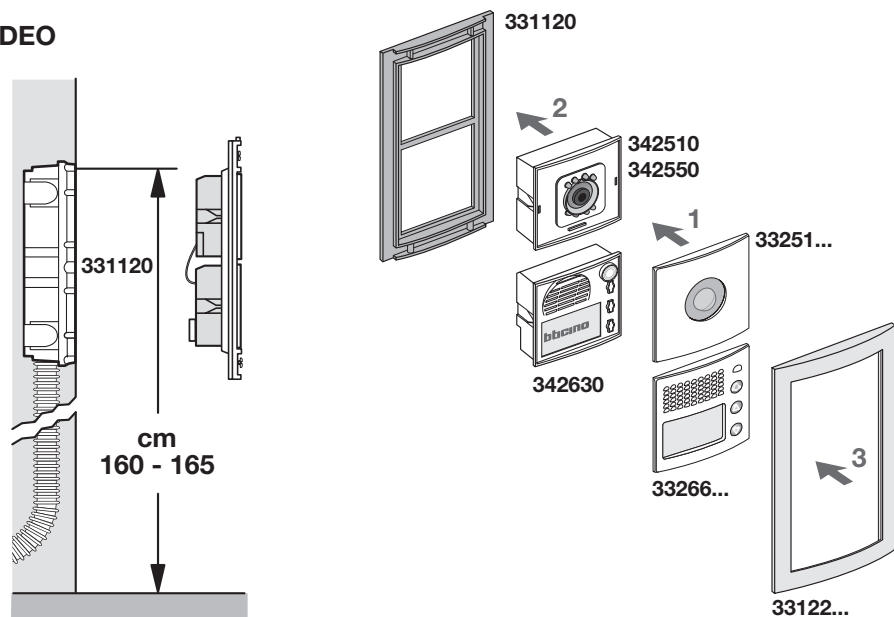
INSTALLAZIONE**AUDIO****VIDEO**

INSTALLAZIONE

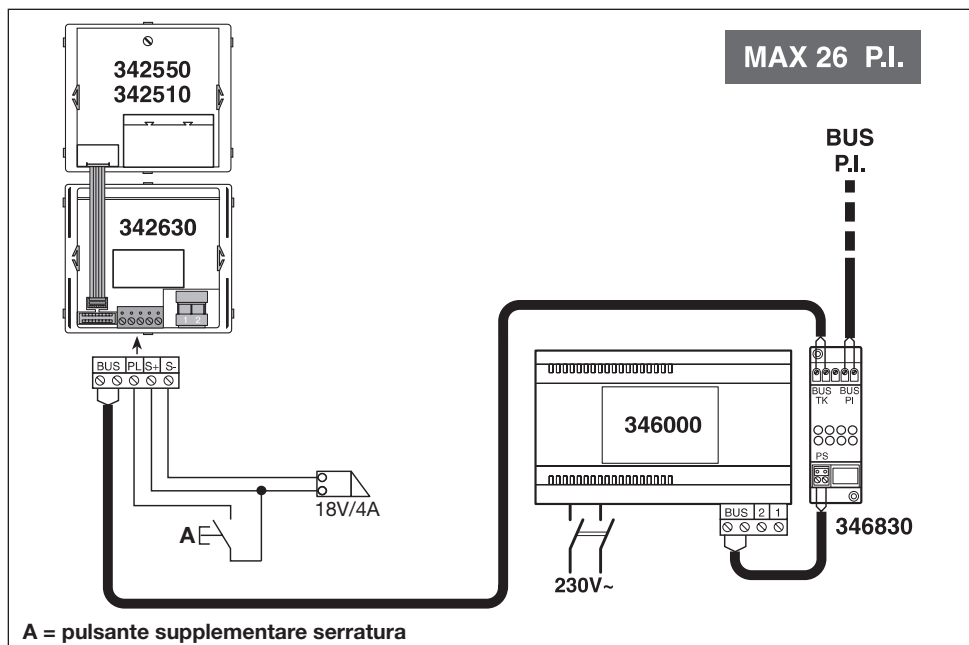
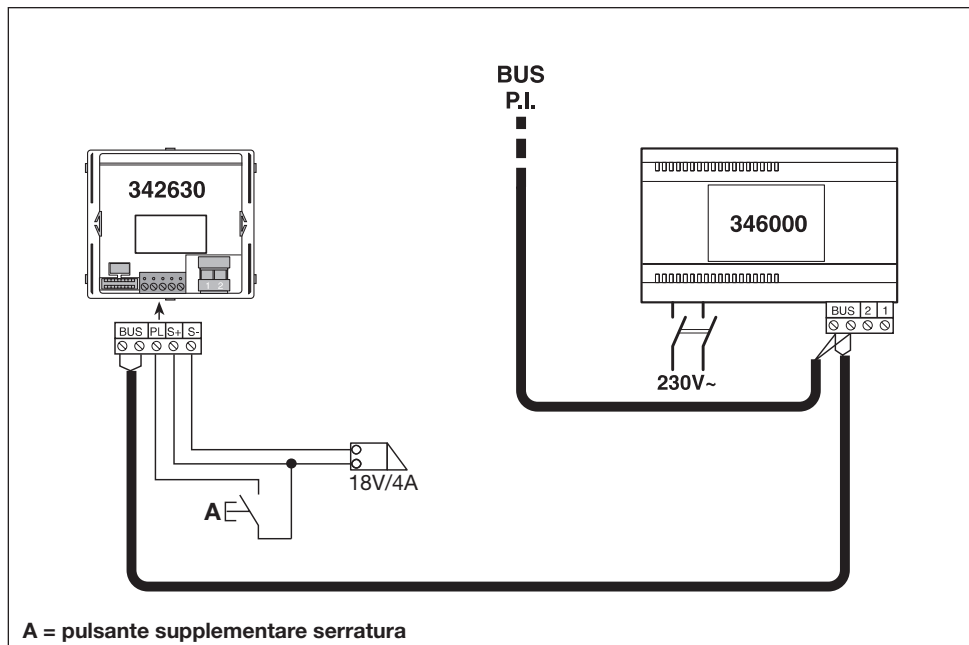

INSTALLAZIONE

MAX 64 P.I.

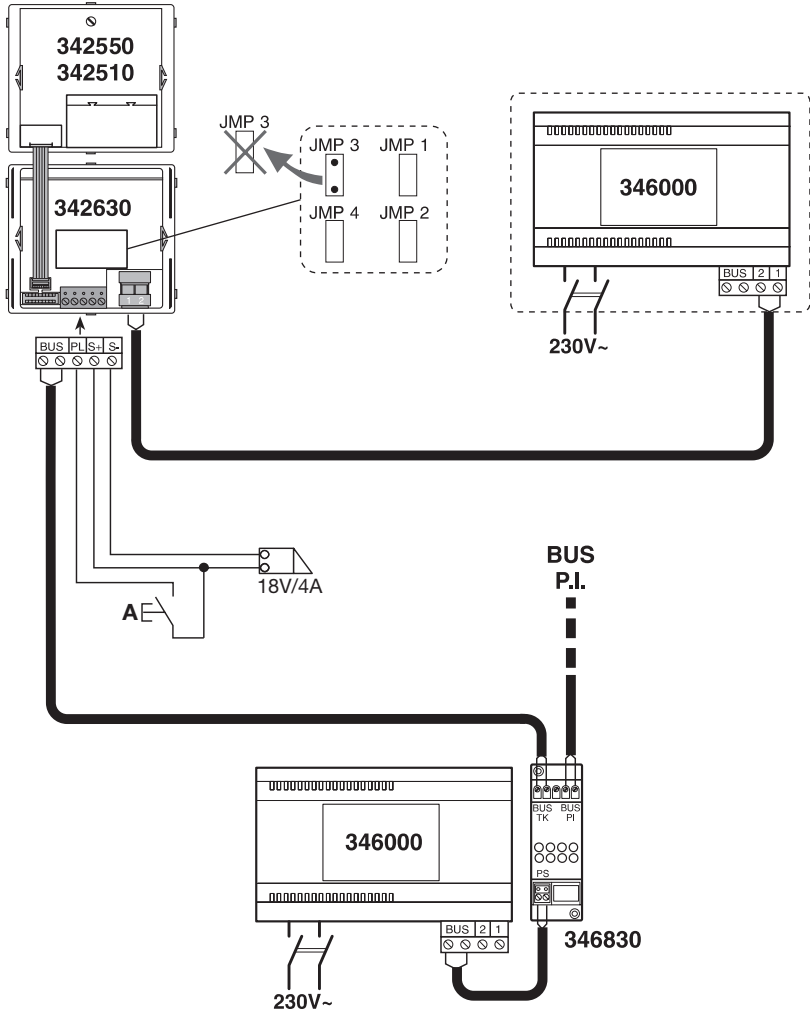

A = pulsante supplementare serratura



A series of horizontal dotted lines spanning the width of the page, intended for writing or drawing.

INDEX

INTRODUCTION	34
Avertissements et conseils	34
Description generale	34
Afficheur graphique	35
Touches et leurs fonctions	35
Configuration d'usine	36
Retablisement configuration d'usine	36
UTILISATION	37
Recherche d'un resident dont on connait le nom	37
Recherche d'un resident dont on connait le code	38
DISPOSITIFS SUPPLEMENTAIRES EXTERIEURS	39
Module clavier supplementaire	39
Telecommande I/R	39
PROGRAMMATION	40
Acces a la programmation	40
Touches et leurs fonctions	40
Menu configuration	42
Mot de passe	43
Langue	44
Format repertoire	45
Conciergerie	46
Appel direct	47
Code cle	48
Contraste	49
Rappel	50
Menu repertoire	51
LOGICIEL TICALL	58
CONFIGURATION	58
INSTALLATION	59



Pour modifier la langue de visualisation des menus:

- accéder à la modalité **Programmation** décrite page 41;
- exécuter la procédure **Langue** décrite page 44.

INTRODUCTION

AVERTISSEMENTS ET CONSEILS

Avant d'installer le module, il importe de lire avec attention cette notice.



Le fabricant décline toute responsabilité pour des dommages éventuels dus à un emploi erroné et/ou non conforme aux instructions contenues dans cette notice.

DESCRIPTION GENERALE

Le module micro HP numérique à afficheur graphique sur fond lumineux, permet d'envoyer l'appel à un poste interne en parcourant les noms ou les codes des résidents sur l'afficheur au moyen des touches dédiées. Le module peut mémoriser jusqu'à 1000 prénoms et noms de résidents en les associant à l'**adresse univoque de configuration*** du PI (Poste Interne) à l'intérieur de l'installation.

Les noms se réduisent à 500, si on leur associe aussi un message. Si pour des raisons de protection de la vie privée, il est décidé de mémoriser seulement les codes des résidents, la possibilité s'élargit à 5000 codes. Il est possible d'associer deux noms différents à la même adresse MN.

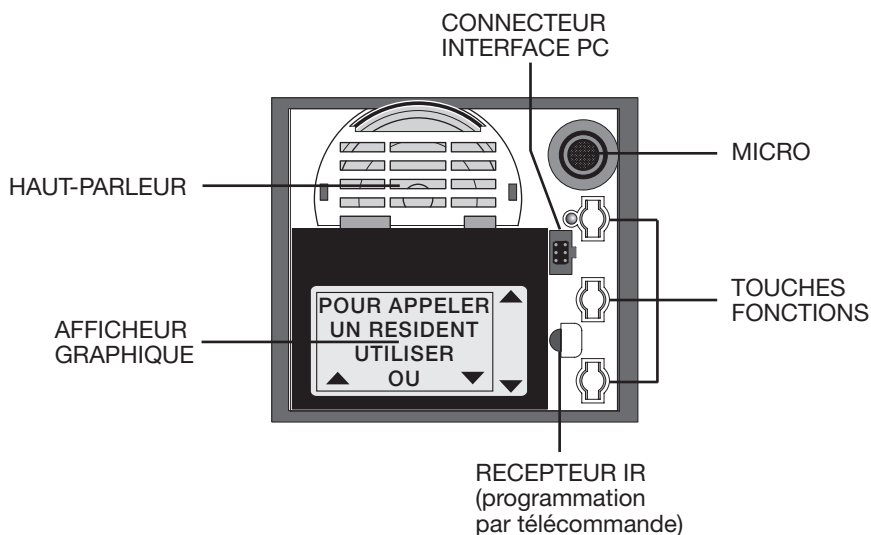

(*) Dans cette notice, la mention "**Adresse univoque de configuration**" sera par la suite notée sous la forme **MN**.

INTRODUCTION

AFFICHEUR GRAPHIQUE

A la position de repos, l'afficheur du portier graphique présente l'écran ci-après pour effectuer un appel à un résident.



 Lorsque les écrans d'appel à la conciergerie et direct sont activés, ils sont montrés l'un à la suite de l'autre et toutes les 10 secondes en alternance avec l'écran de repos.



TOUCHES ET LEURS FONCTIONS

A l'aide des trois touches du module, il est possible de rechercher dans le répertoire, visualisé sur l'afficheur, le nom ou le code du résident et d'envoyer l'appel.



- Appeler le résident sélectionné



- Se déplacer à la position précédente ▲ (pression brève)
- Défilement rapide ▲ (pression longue 2 secondes)



- Se déplacer à la position suivante ▼ (pression brève)
- Défilement rapide ▼ (pression longue 2 secondes)



DEFILEMENT RAPIDE: sur l'afficheur sont visualisés plusieurs résidents en même temps.

INTRODUCTION

CONFIGURATION D'USINE

Mot de passe	1234
Langue	Italien
Format répertoire	Alphabétique sans message
Conciergerie	4000 mis hors fonction
Appel direct	0000 et 0001 mis hors fonction
Code clé	1234, 1235, 1236, 1237 e 1238
Contraste	50
Rappel	mis hors fonction

RETABLISSEMENT CONFIGURATION D'USINE

Pour rétablir la configuration d'Usine:

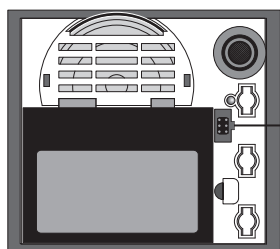

- Couper l'alimentation du dispositif
- Insérer un cavalier entre les deux broches inférieures de l'interface

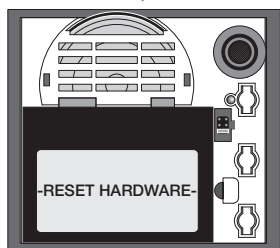

- Réalimenter le dispositif, sur l'afficheur est visualisé le message suivant:
- REMISE A ZERO HARDWARE -
- Couper l'alimentation du dispositif

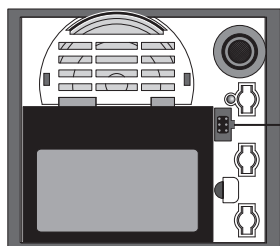

- Retirer le cavalier
- Réalimenter le dispositif, la configuration d'usine est rétablie.

UTILISATION

RECHERCHE D'UN RESIDENT DONT ON CONNAIT LE NOM

Pour appeler un résident dont on connaît le nom:

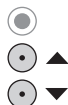

- Appuyer sur une touche pour accéder à la recherche;

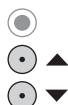
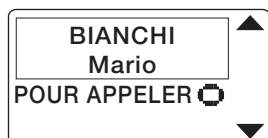

- parcourir le répertoire jusqu'à l'apparition sur l'afficheur du nom souhaité;

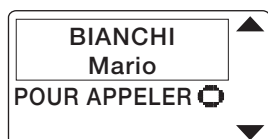

- appuyer sur la touche pour adresser l'appel.

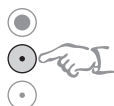

- En cas de non réponse, il est possible d'interrompre l'appel en appuyant sur la touche.

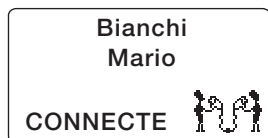

Lorsque le résident répond, l'afficheur signale que la conversation est en cours.



Lorsque le résident raccroche le combiné de l'appareil interne, ou si 60 secondes se sont écoulées, la communication est interrompue et l'afficheur revient à la position de repos.



Ce type de recherche est possible seulement si le Format du Répertoire a été programmé en ALPHABETIQUE.

UTILISATION

RECHERCHE D'UN RESIDENT DONT ON CONNAIT LE CODE

Pour appeler un résident dont on connaît le code:

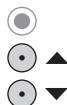

- Appuyer sur une touche pour accéder à la recherche;

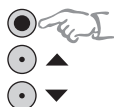
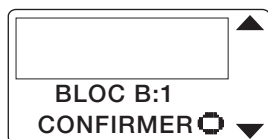

- Sélectionner à l'aide des touches le Bâtiment, l'Etage et le Poste interne souhaités et confirmer le choix.

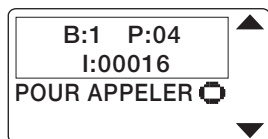

- Appuyer sur la touche pour envoyer l'appel.

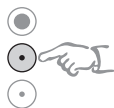
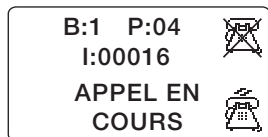

- En cas de non réponse, il est possible d'interrompre l'appel en appuyant sur la touche.



Lorsque le résident répond, l'afficheur signale que la conversation est en cours.

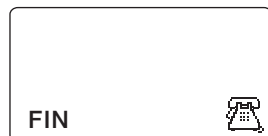

Lorsque le résident raccroche le combiné de l'appareil interne, ou si 60 secondes se sont écoulées, la communication est interrompue et l'afficheur revient à la position de repos.



Ce type de recherche est possible seulement si le Format du Répertoire a été programmé en CODE. Les codes doivent être programmés dans la phase d'installation, en associant au résident un code d'identification: B (bâtiment), E (étage) et P I (poste interne).

DISPOSITIFS SUPPLEMENTAIRES EXTERIEURS

MODULE CLAVIER SUPPLEMENTAIRE

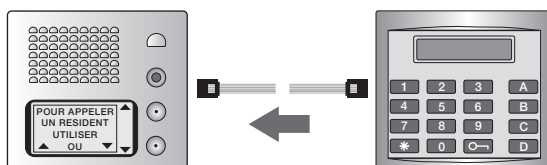

Le module clavier (réf. 342640) permet de:

- Appeler directement le résident dont on connaît le nom (si le Format du Répertoire a été programmé comme ALPHABETIQUE), en composant l'adresse MN sur le clavier.
- Appeler directement le résident dont on connaît le code (si le Format du Répertoire a été programmé comme CODE), en composant le code (Bâtiment, Etage et Poste Interne) sur le clavier.
- Ouvrir la serrure, en appuyant sur  et en tapant un code numérique.

Le module clavier est livré avec un câble en nappe pour le raccordement au module micro HP.

TELECOMMANDE I/R



La télécommande à rayons infra-rouges (réf. 392123) peut être utilisée pour programmer le répertoire des résidents.

En plus des touches qui indiquent lettres et chiffres, d'autres touches existent pour des fonctions particulières de programmation:

- NEXT MESS sélection article suivant/précédent
- SHIFT modification de la fonction de NEXT MESS et de toutes les touches à signification double
- RESET sortir de la phase d'édition, en perdant tous les nouveaux paramètres
- MEMORY mémorisation de la nouvelle donnée ou de la nouvelle sélection
- BACK déplace vers la gauche d'une position
- SPACE déplace vers la droite d'une position
- SHIFT + " . " insertion d'un espace (appuyer sur SHIFT, puis sur " . ")

PROGRAMMATION

ACCES A LA PROGRAMMATION

L'accès à la programmation du Portier Graphique est protégé par un Mot de Passe (d'usine **1234**).



Une fois entré dans Programmation, il est possible de sélectionner:

- CONFIGURATION – pour entrer dans les menus de configuration du dispositif.
- REPERTOIRE – pour entrer dans le menu de configuration du répertoire.
- SORTIE – pour sortir de la programmation et retourner à la page d'ouverture.

TOUCHES ET LEURS FONCTIONS



- Déplacer vers la droite d'un chiffre le curseur (pression brève)
- Confirmer et mémoriser (*pression longue 2 secondes*)



- Glisser d'une position ▲ (*pression brève*)
- Augmenter d'une unité (*pression brève*)



- Glisser d'une position ▼ (*pression brève*)
- Diminuer d'une unité (*pression brève*)

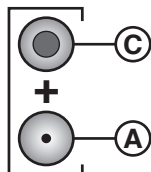

- Les touches **C** + **A** appuyées en même temps, font déplacer le curseur d'un chiffre vers la gauche (*Typiquement d'abord C, puis A*)

PROGRAMMATION

Pour accéder à la programmation:



- Maintenir appuyée la touche pendant au moins 10 secondes;

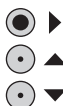
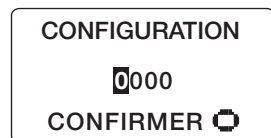

- insérer à l'aide des touches le mot de passe (ex.: 1234 mot de passe d'usine);

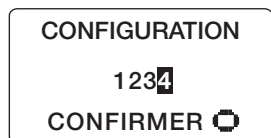

- maintenir appuyée la touche pendant au moins 2 secondes pour confirmer.



Si le mot de passe est correct:

- on accède à la programmation

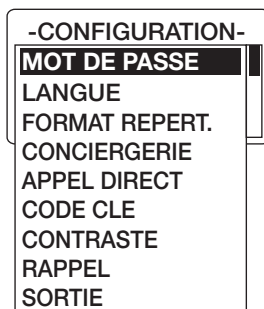

- sinon on retourne à la page d'ouverture

PROGRAMMATION**MENU CONFIGURATION**

Dans ce menu on peut configurer:

- MOT DE PASSE – le mot de passe d'accès à la programmation.
- LANGUE – la langue de visualisation des menus.
- FORMAT REPERTOIRE – le format du répertoire (alphabétique/code).
- CONCIERGERIE – l'écran d'appel à la conciergerie.
- APPEL DIRECT – l'écran d'appel direct à deux postes internes privilégiés.
- CODE CLE – le code d'ouverture de la porte (max. 5 codes différents).
- CONTRASTE – la valeur du contraste de l'afficheur (30÷70).
- RAPPEL – la tonalité de rappel automatique (toutes les 10 secondes 4 fois).

PROGRAMMATION

MOT DE PASSE

Pour modifier le code d'accès à la programmation (d'Usine **1234**):

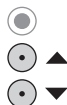
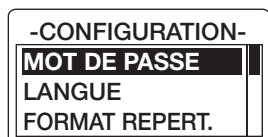

- Sélectionner **Mot de Passe**;



- appuyer sur la touche pour confirmer;

Sur l'afficheur se trouve visualisé le mot de passe en usage

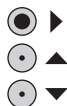

- insérer à l'aide des touches le nouveau mot de passe (ex. 2244);



- maintenir appuyée pendant 2 secondes la touche pour mémoriser le nouveau mot de passe.

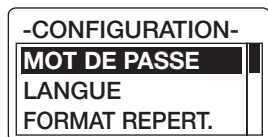

Sur l'afficheur est visualisée la page d'ouverture



Si plus de 7 secondes s'écoulent entre la pression sur une touche et la suivante, l'afficheur revient à la position de repos, en conservant programmé l'ancien mot de passe.

PROGRAMMATION

LANGUE

Pour modifier la langue du dispositif (d'Usine – **Italien**):

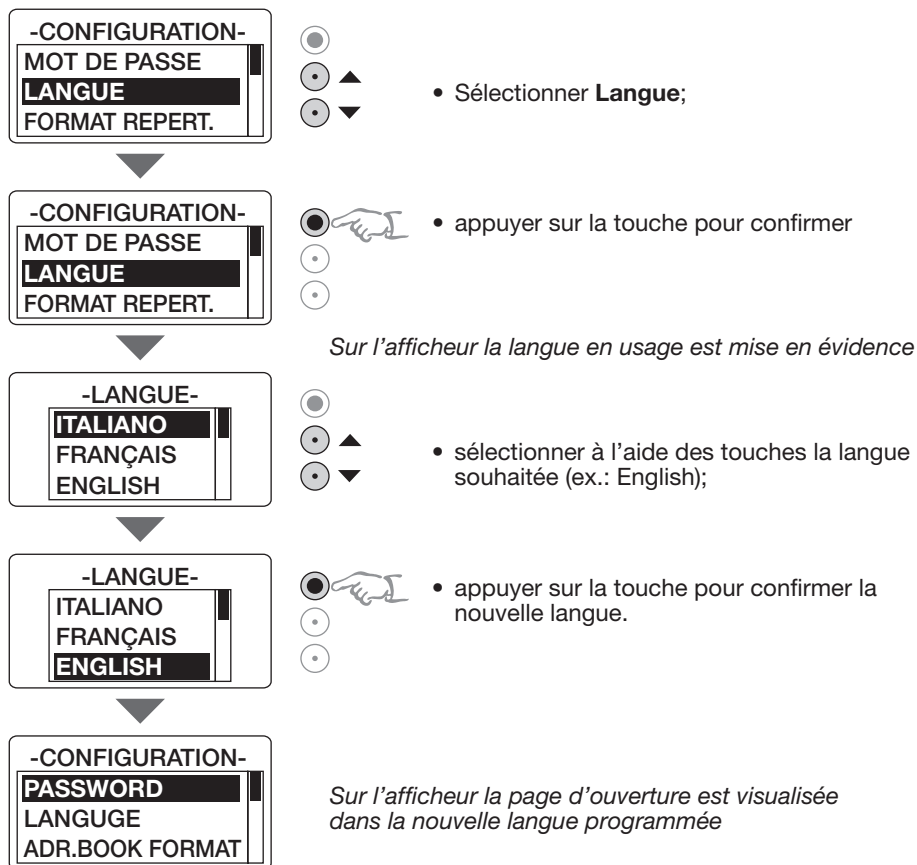

Il est possible de remplacer la langue «Courante» par une langue prédéfinie au moyen du logiciel TiCall.

PROGRAMMATION

FORMAT REPERTOIRE

Pour modifier le format du répertoire du dispositif (d'Usine – **alphabétique sans message**):

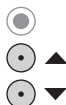

- Sélectionner **Format Répertoire**

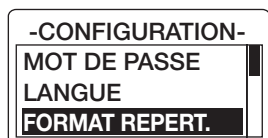

- Appuyer sur la touche pour confirmer

Sur l'afficheur le format en usage est mis en évidence

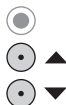
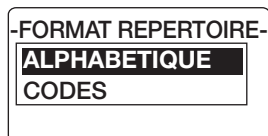

- sélectionner à l'aide des touches le nouveau format*;



- appuyer sur la touche pour confirmer. ⚠

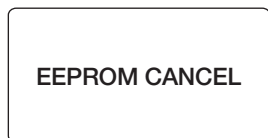

La modification ou la confirmation du “Format répertoire” en usage détermine l’effacement de toutes les données contenues dans le répertoire des résidents.

(*) Les choix possibles sont:

ALPHABETIQUE:

- **sans message**: max. **1000** résidents (nom + prénom)
- **avec message**: max. **500** résidents (nom + prénom + message)

CODE: max. **5000** résidents (code)

PROGRAMMATION

CONCIERGERIE

Pour activer l'écran d'appel à la conciergerie:

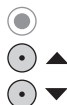
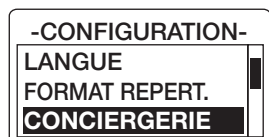

- Sélectionner **Conciergerie**

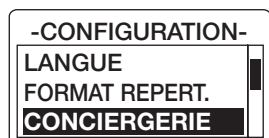

- Appuyer sur la touche pour confirmer

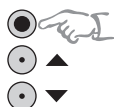
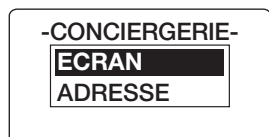

- Sélectionner à l'aide des touches:
 - **Ecran** pour activer/désactiver l'écran d'appel à la conciergerie (par défaut: mis hors fonction)
 - **Adresse** pour programmer l'adresse MN de la conciergerie (par défaut: 4000)
- Confirmer le choix

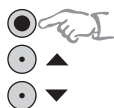

- Sélectionner à l'aide des touches le choix souhaité et confirmer



Lorsque l'écran d'appel à la conciergerie est activé, ce dernier est montré toutes les 10 secondes en suite alternée avec l'écran de repos.

PROGRAMMATION

APPEL DIRECT

Pour activer l'écran d'appel à deux postes internes privilégiés:

-CONFIGURATION-
FORMAT REPERT.
CONCIERGERIE
APPEL DIRECT

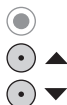

- Sélectionner **Appel Direct**;



-CONFIGURATION-
FORMAT REPERT.
CONCIERGERIE
APPEL DIRECT



- appuyer sur la touche pour confirmer;



-APPEL DIRECT-
ECRAN
ADRESSE

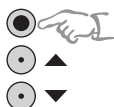

- sélectionner à l'aide des touches:
 - **Ecran** pour activer/désactiver l'écran d'appel direct à deux postes internes privilégiés (par défaut: mis hors fonction)
 - **Adresse** pour programmer l'adresse MN des postes internes privilégiés (d'Usine: 0000 et 0001)
- confirmer le choix;



-ECRAN-
METTEZ HORS FUN
PERMETTEZ

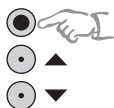

- sélectionner à l'aide des touches le choix souhaité et confirmer.

BIANCHI 

ROSSI 



Lorsque l'écran d'appel direct est activé, ce dernier est montré toutes les 10 secondes en suite alternée avec l'écran de repos.



Il est possible d'activer cette fonction seulement si le Format Répertoire a été configuré en Alphabétique.

PROGRAMMATION

CODE CLE

Cette fonction permet de programmer jusqu'à 5 codes différents d'ouverture de la porte (d'Usine 1234, 1235, 1236, 1237 et 1238).

Pour modifier le code d'ouverture de la porte:

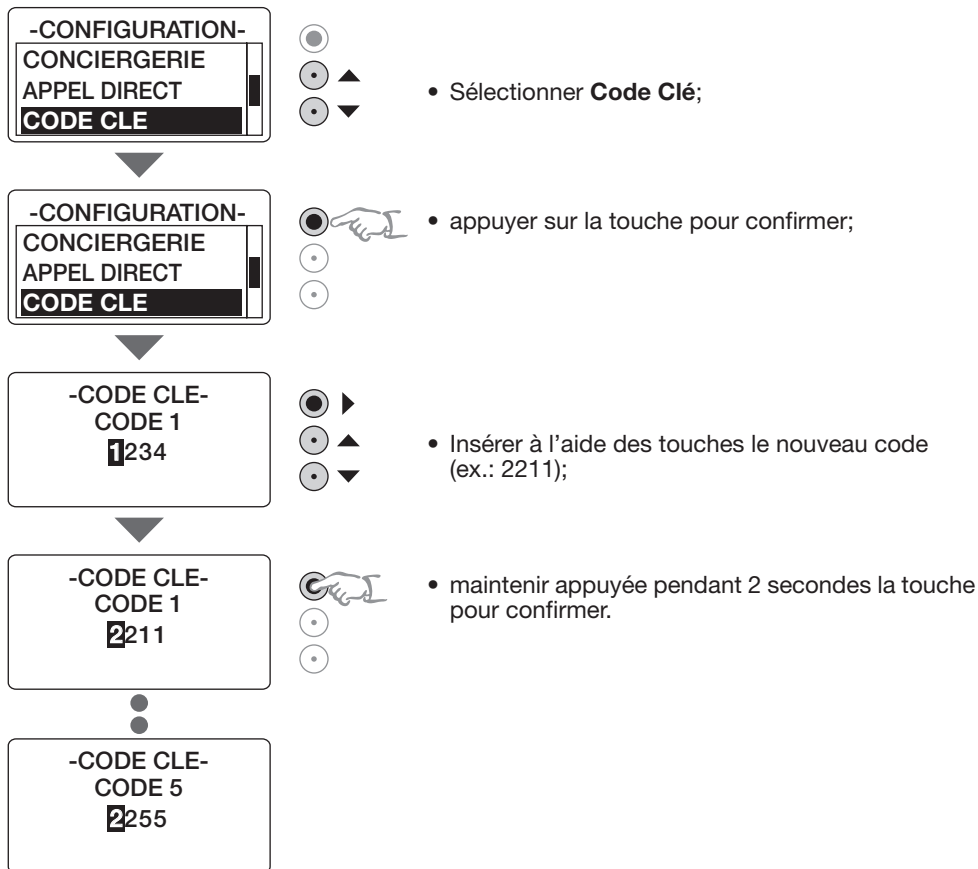

Exemple: si l'on assigne les **codes clés** avec la logique suivante:

- CODE 1** - résidents
- CODE 2** - service de surveillance
- CODE 3** - service d'entretien
- CODE 4** - facteur
- CODE 5** - service eau et gaz

il sera possible de modifier un code assigné (ex.:facteur) tout en laissant les autres inchangés.

PROGRAMMATION

CONTRASTE

Pour modifier la valeur du contraste de l'afficheur (d'Usine – 70):

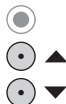

- Sélectionner **Contraste**;



- appuyer sur la touche pour confirmer;

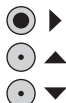

- insérer à l'aide des touches la nouvelle valeur (comprise entre 30 et 90);



- maintenir appuyée pendant 2 secondes la touche pour confirmer.

PROGRAMMATION

RAPPEL

Pour activer la tonalité de rappel automatique, quatre fois 10 secondes (d'Usine – mise hors fonction):

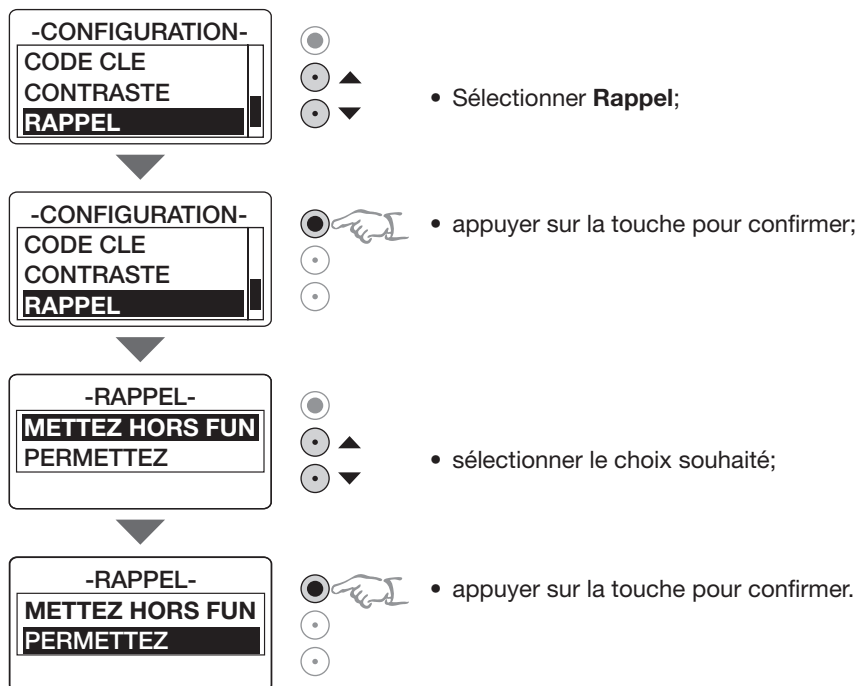

PROGRAMMATION

MENU REPERTOIRE

Dans ce menu, on peut insérer dans le répertoire de nouveaux résidents, modifier les données saisies ou les effacer.

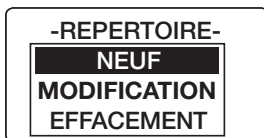

Les menus varient en fonction du «Format répertoire» programmé Alphabétique ou Code.

Pour accéder au menu répertoire:

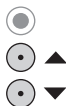

- Sélectionner **Répertoire**;



- Appuyer sur la touche pour confirmer;



- Sélectionner la fonction souhaitée.



PROGRAMMATION

Nouveau (Alphabétique)

Pour insérer un nouveau résident dans le répertoire:

-REPERTOIRE-
NEUF
 MODIFICATION
 EFFACEMENT



- Appuyer sur la touche pour confirmer;

-NEUF-
 NOM:
 |

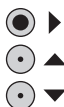

- insérer à l'aide des touches les nouvelles données;
 - NOM
 - PRENOM
 - MESSAGE (si Alphabétique avec message)
 - ADRESSE MN

-NEUF-
 NOM:
 BAI
 PRENOM:
 |



- maintenir appuyée pendant 2 secondes la touche pour mémoriser chacune d'elles

-NEUF-
 ADRESSE MN:
 0012



RESIDENT INSERE
 NOMBRE RESIDENTS
 0001

PROGRAMMATION

Modification (Alphabétique)

Pour modifier les données d'un résident présent dans le répertoire:

-REPERTOIRE-
NEUF
MODIFICATION
EFFACEMENT



- Appuyer sur la touche pour confirmer;



BAI
ALDO

CONFIRMER

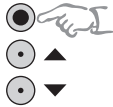

- sélectionner à l'aide des touches le résident à modifier et confirmer;



VOULES MODIFIER
LE RESIDENT
SELECTIONNE?



- Appuyer sur la touche pour confirmer;



-MODIFICATION-
NOM:
BAI
PRENOM:
|



- insérer à l'aide des touches les nouvelles données;
- NOM
- PRENOM
- MESSAGE (si Alphabétique avec message)
- ADRESSE MN



-MODIFICATION-
NOM:
BUI
PRENOM:
ALDO



- maintenir appuyée pendant 2 secondes la touche pour mémoriser chacune d'elles.



OPERATION
EXECUTEE

NOMBRE RESIDENTS
0001

PROGRAMMATION

Effacement (Alphabétique)

Pour effacer un résident du répertoire:

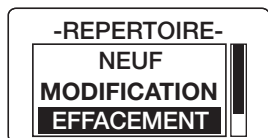

• Appuyer sur la touche pour confirmer;

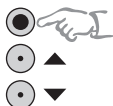

• sélectionner à l'aide des touches le résident à effacer du répertoire et confirmer;

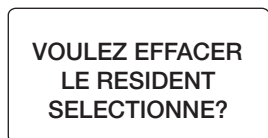

• Appuyer sur la touche pour confirmer.

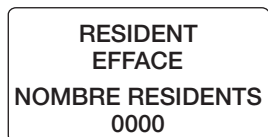

PROGRAMMATION

Nouveau (Code)

Pour insérer un nouveau résident dans le répertoire:

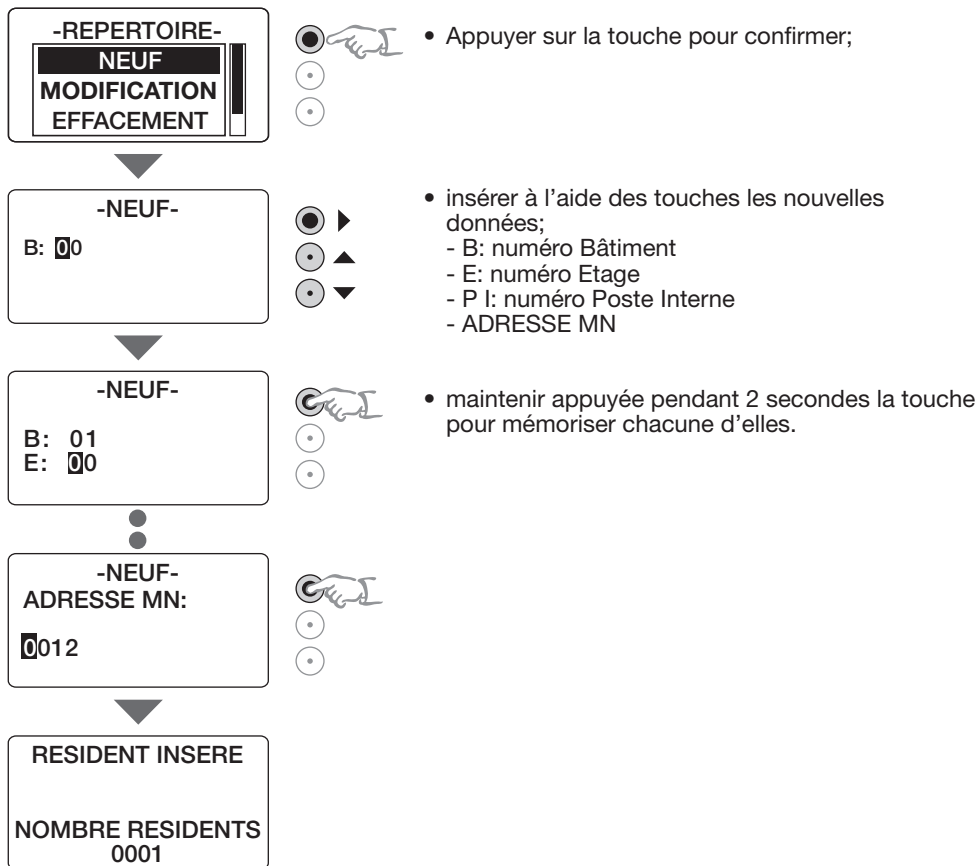

PROGRAMMATION

Modification (Code)

Pour modifier les données d'un résident présent dans le répertoire:

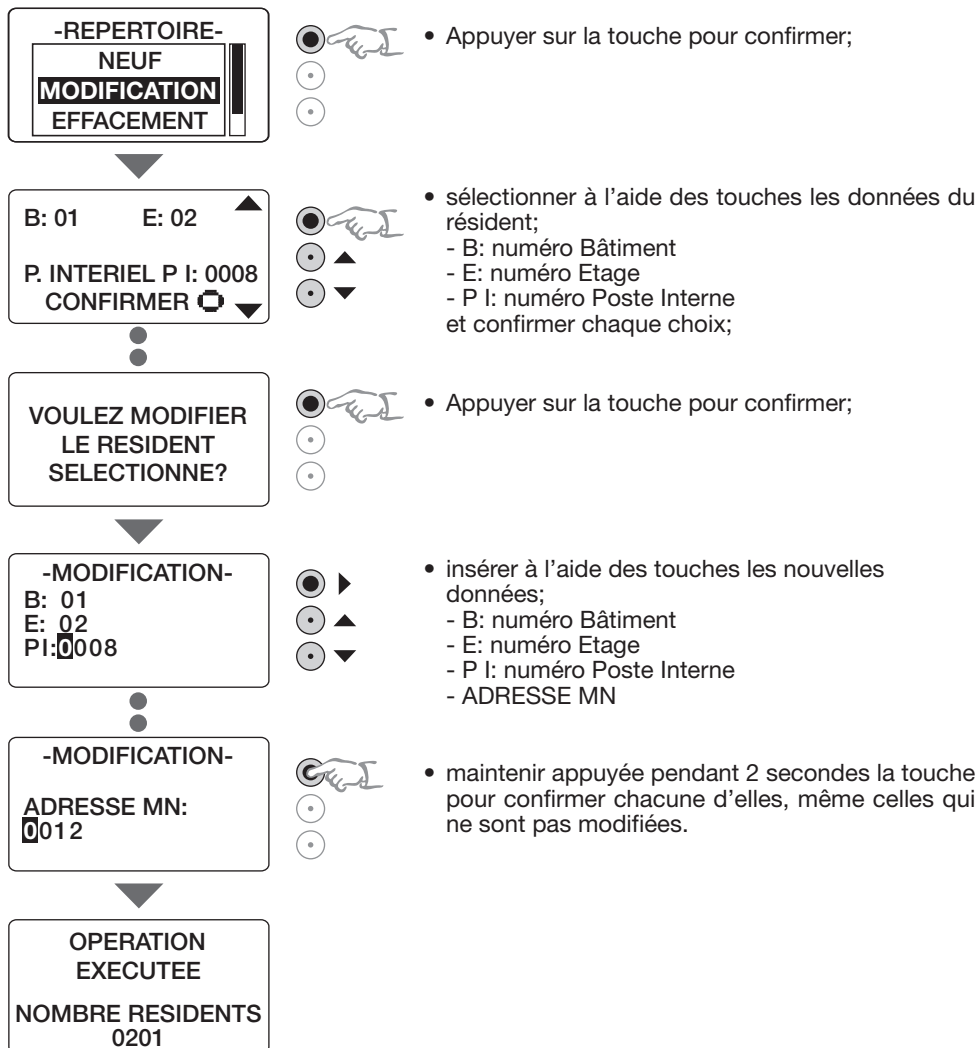

PROGRAMMATION

Effacement (Code)

Pour effacer un résident dans le répertoire:

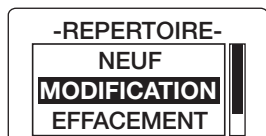

- Appuyer sur la touche pour confirmer;

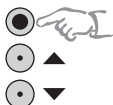
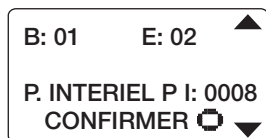

- sélectionner à l'aide des touches les données du résident;
 - B: numéro Bâtiment
 - E: numéro Etage
 - P I: numéro Poste Interne
- et confirmer chaque choix;

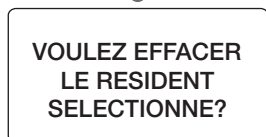

- Appuyer sur la touche pour confirmer.

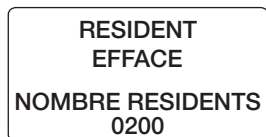

LOGICIEL TICALL

Le logiciel TICALL permet la programmation de tous les paramètres présents dans les menus de configuration du dispositif, au moyen d'un PC avec système opérationnel Microsoft.

La programmation des fonctions ci-dessus peut être effectuée, alors que le dispositif est déjà installé, à l'aide d'un bus SCS, ou bien avant l'installation (il suffit d'alimenter le module micro HP), en le raccordant à la porte RS232 du PC à l'aide du câble d'interface série (réf. 335919). Pour transférer la programmation, l'afficheur du module doit visualiser la page d'ouverture (position de repos).

En assignant à chaque programmation personnalisée un nom, il sera possible d'en gérer l'archivage comme un quelconque fichier

Le logiciel permet en outre de procéder à l'actualisation firmware du dispositif et au remplacement de la langue «Courante» par une langue prédéfinie au moyen du câble d'interface série (réf. 335919).

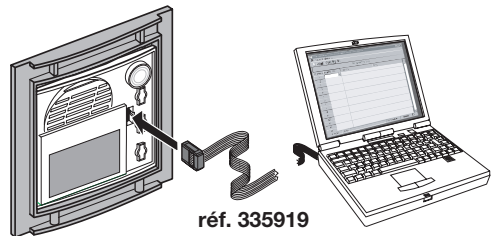

réf. 335919

CONFIGURATION

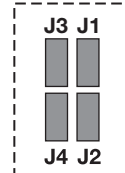
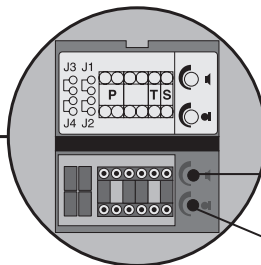
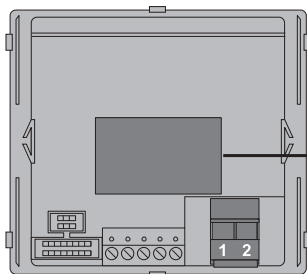

Réglage volume haut-parleur

Réglage sensibilité du micro

P – numéro du poste interne

Le configurateur inséré dans le logement P du module micro HP assigne à ce dernier un numéro de reconnaissance à l'intérieur du système.

Le poste extérieur principal ne doit pas être configuré en P, tandis que tous les autres postes extérieurs doivent être numérotés de façon progressive.

T – temporisation du relais serrure

		numéro du configurateur						
0= Aucun configurateur		1	2	3	4	5	6	7
4 sec.		1 sec.	2 sec.	3 sec.	comme touche	6 sec.	8 sec.	10 sec.

S – type de signal d'appel

La configuration de S détermine la tonalité de l'appel des postes internes. Il est ainsi possible de différencier les appels provenant de postes extérieurs différents.

Configurateur	0	1	2	3
Type de sonnerie	A deux tons	A deux tons	A deux tons	A un ton
	1200 Hz	1200 Hz	1200 Hz	1200 Hz
	600 Hz	0 Hz	2400 Hz	

J4 – confirmation appel sur PE

Pour éliminer la tonalité d'appel sur le poste extérieur, retirer le cavalier J4.

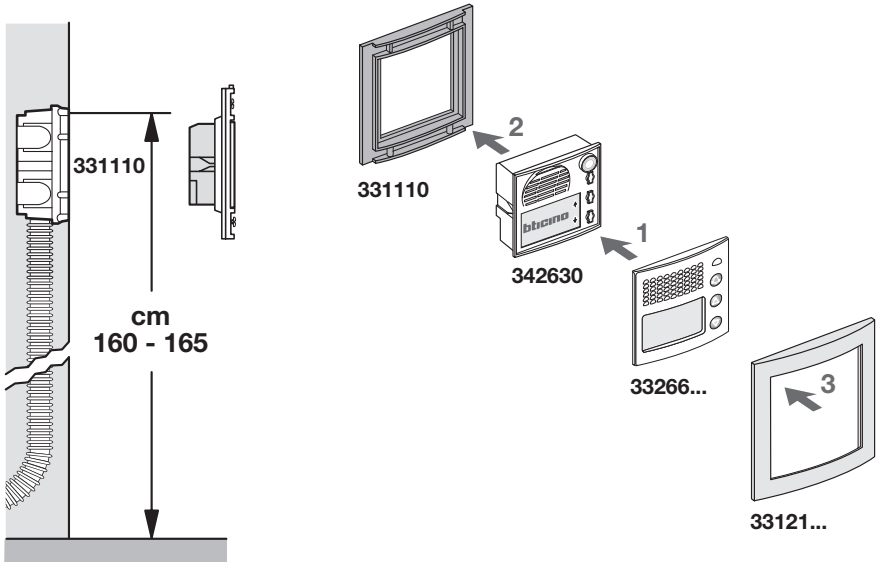
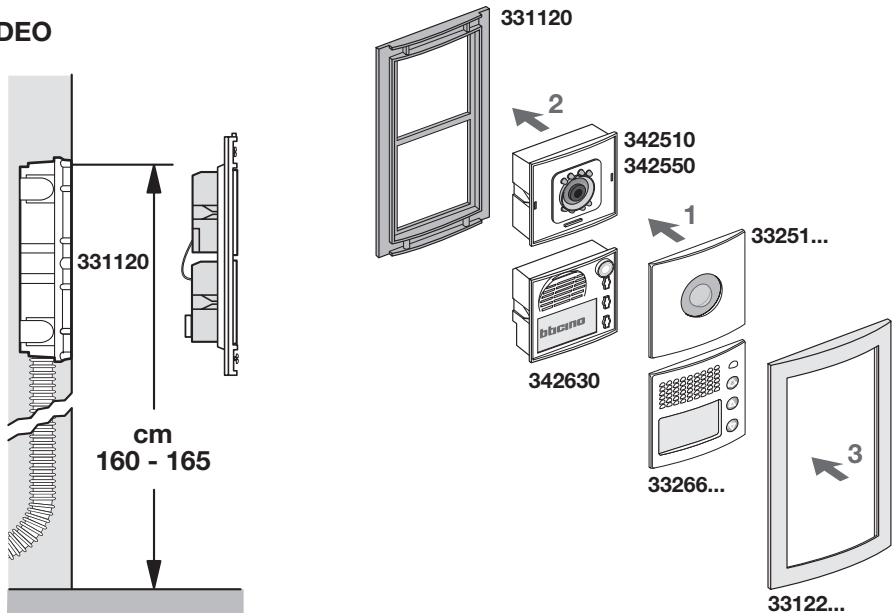
INSTALLATION**AUDIO****VIDEO**

INSTALLATION

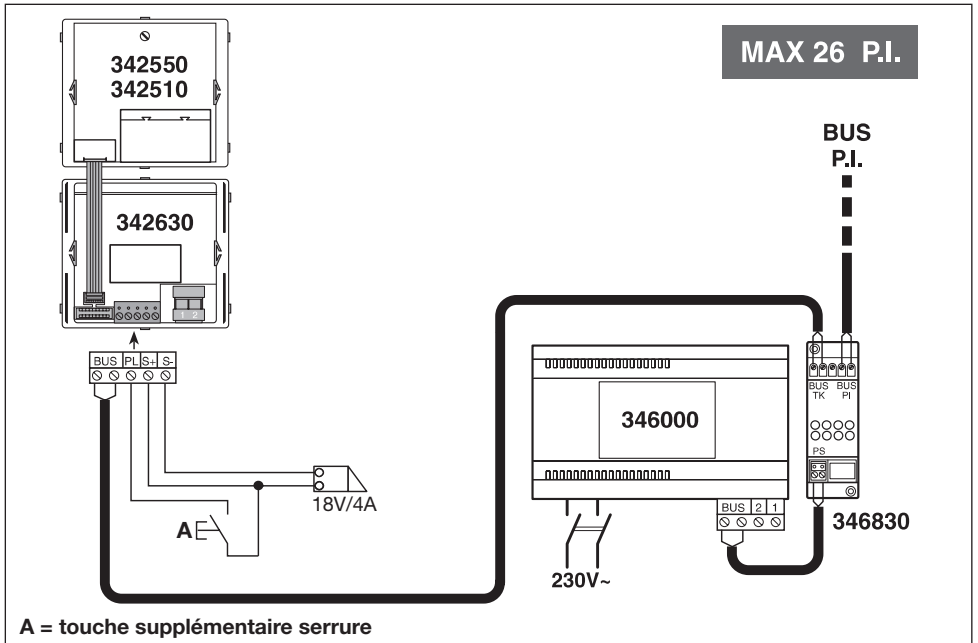
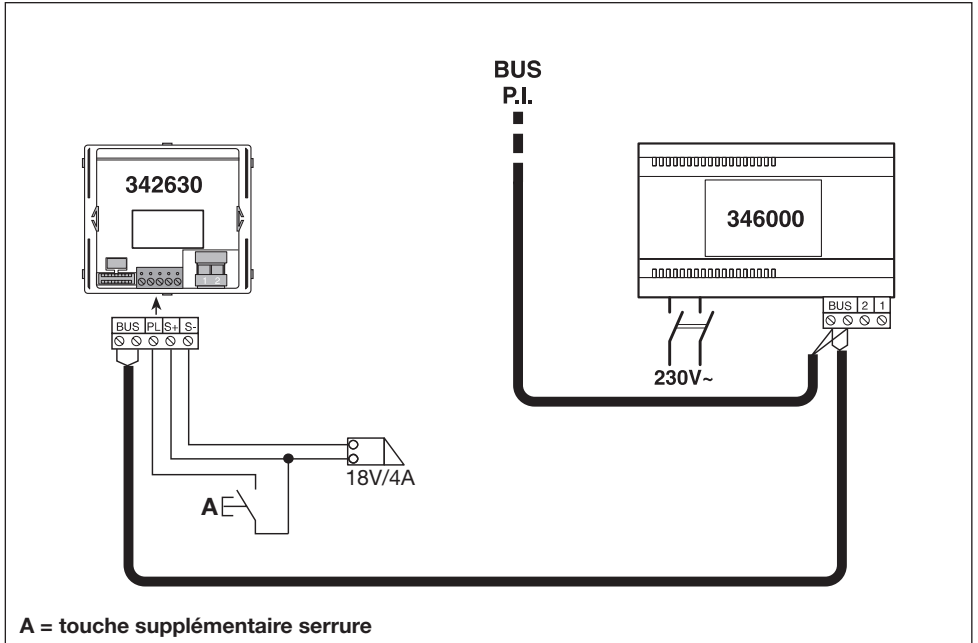

INSTALLATION

MAX 64 P.I.

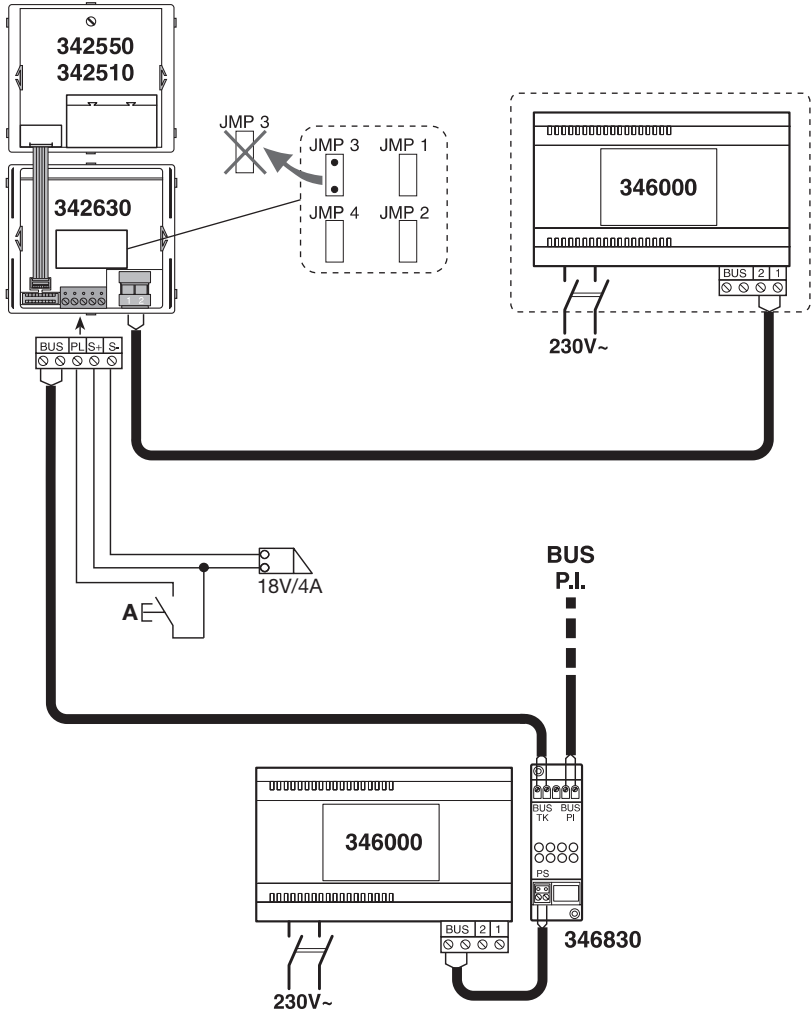

A = touche supplémentaire serrure



A series of horizontal dotted lines spanning the width of the page, intended for handwriting practice or notes.

CONTENTS

INTRODUCTION	64
Warnings and tips	64
General description	64
Graphic display	65
Pushbuttons and their functions	65
Factory configuration	66
Reset factory configuration	66
USE	67
Looking for a resident whose name you know	67
Looking for a resident whose code you know	68
EXTRA EXTERNAL DEVICES	69
Extra keypad module	69
I/R remote control	69
PROGRAMMING	70
Access to the programming	70
Pushbuttons and their functions	70
Configuration menu	72
Secret code	73
Language	74
Address book format	75
Distribution board	76
Direct call	77
Door code	78
Contrast	79
Recall	80
Address book menu	81
TICALL SOFTWARE	88
CONFIGURATION	88
INSTALLATION	89



To change the menu display language:

- **access the Programming mode described** on page 71;
- **perform the Language procedure described** on page 74.

INTRODUCTION

WARNINGS AND TIPS

Read this manual carefully before installing the module.

 *The manufacturer declines all responsibility for any damage due to incorrect use and/or use which does not conform to the instructions in this manual.*

GENERAL DESCRIPTION

The digital speaker module with backlit graphic display can send the call to an internal unit. You can scroll the resident names or codes on the display by means of the dedicated keys. The module can save up to 1000 resident names and surnames associating them to the **unique configuration address*** of the IU (Internal Unit) inside the system. It can save 500 names if a message is associated with them. Whenever, for privacy reasons, you decide to save only the resident codes, up to 5000 codes can be saved. Two different names can be associated to the same MN address.

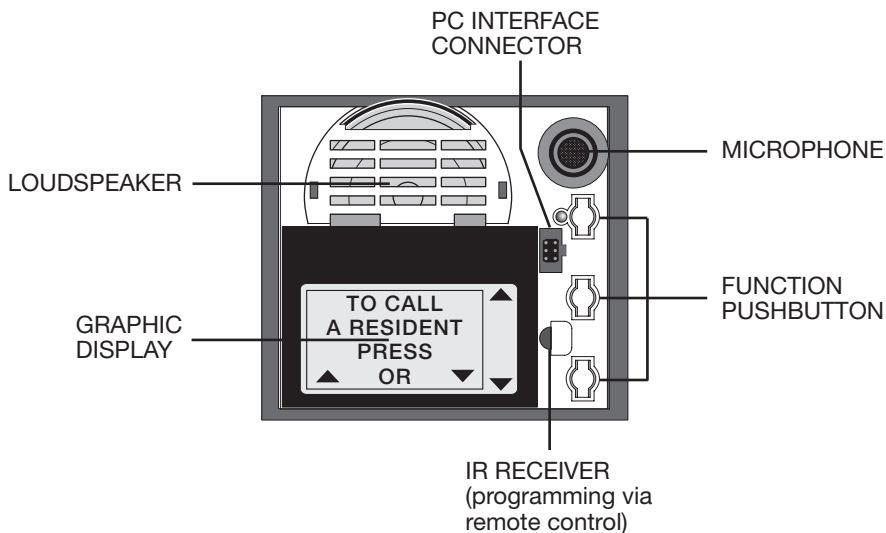

(*) In this manual “**Unique configuration address**” will be abbreviated to **MN**.

INTRODUCTION

GRAPHIC DISPLAY

In the rest position the graphic distribution board display shows the screen to call a resident.





 *When the call to the distribution board and direct screens are enabled, they are shown in succession and every ten seconds, alternating with the rest screen.*



PUSHBUTTONS AND THEIR FUNCTIONS

Use the three module pushbuttons to search in the address book, shown on the display, for the resident name or code and make the call.

 • Call the resident selected

 • Scroll to a previous position ▲ (short press)
• Fast scroll ▲ (long 2-second press)

 • Scroll to a later position ▼ (short press)
• Fast scroll ▼ (long 2-second press)



FAST SCROLL: The display shows several residents at once.

INTRODUCTION

FACTORY CONFIGURATION

Secret code	1234
Language	Italian
Address book format	Alphanumeric without message
Distribution board	4000 Disabled
Direct call	0000 and 0001 Disabled
Door code	1234, 1235, 1236, 1237 and 1238
Contrast	50
Recall	Disabled

RESET FACTORY CONFIGURATION

To reset the Factory configuration:

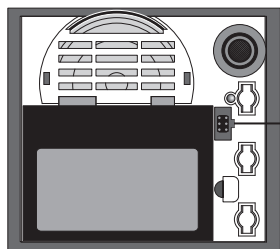

- Switch off the power supply to the device
- Put a jumper on the two lower interface pins

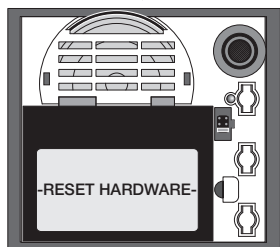

- Switch the device back on. The following message appears on the display:
- RESET HARDWARE -
- Switch off the power supply to the device

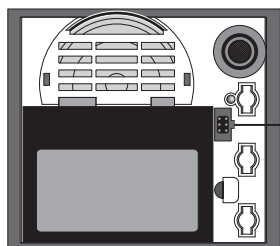

- Remove the jumper
- Switch the device back on.
The Factory configuration is reset

USE

LOOKING FOR A RESIDENT WHOSE NAME YOU KNOW

To call a resident whose name you know:

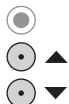

- Press a pushbutton to access the search;

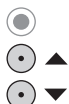
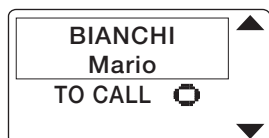

- scroll the address book until the name required appears on the display;

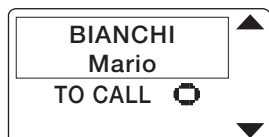

- press the pushbutton to make the call;

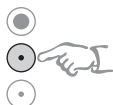
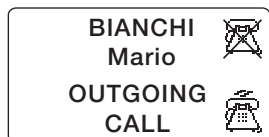

- if there is no reply press the pushbutton to interrupt the call;

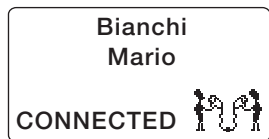

When the resident answers the display signals that the conversation is in progress.

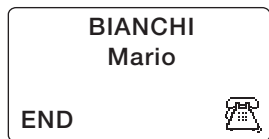

When the resident puts down the handset of the internal device, or after 60 seconds, the call is interrupted and the display returns to the rest position.



This type of search is only possible if ALPHANUMERIC has been set as Address book Format.

USE

LOOKING FOR A RESIDENT WHOSE CODE YOU KNOW

To call a resident whose code you know:



- Press a pushbutton to access the search;

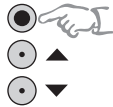
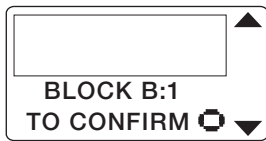

- Use the pushbuttons to select the Block, Floor and Extension required and confirm each choice.

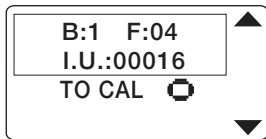

- Press the pushbutton to make the call;

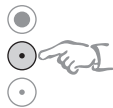
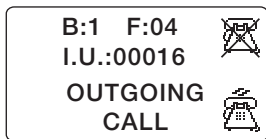

- If there is no reply press the pushbutton to interrupt the call;

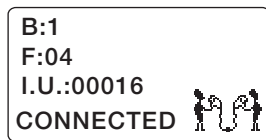

When the resident answers the display signals that the conversation is in progress.

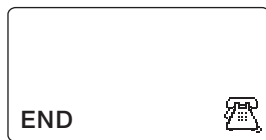

When the resident puts down the handset of the internal device, or after 60 seconds, the call is interrupted and the display returns to the rest position.



This type of search is only possible if CODE has been set as Address book Format. The codes must be programmed in the installation phase, associating an identification code: B (block), F (floor) and I.U. (extension) with the resident.

EXTRA EXTERNAL DEVICES

EXTRA KEYPAD MODULE

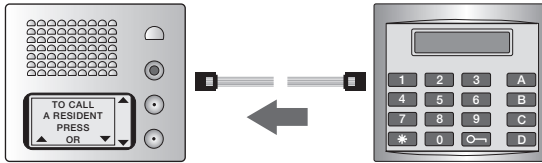

The keypad module (item 342640) can:

- Call directly the resident whose name is known (if *ALPHANUMERIC* has been set as *Address book Format*), keying in the MN address on the keypad.
- Call directly the resident whose code is known (if *CODE* has been configured as *Address book Format*), keying in the code (Block, Floor, Extension) on the keypad.
- Open the door lock by pressing the  pushbutton and typing a numerical code.

The keypad module is supplied with a multicable for the connection to the speaker module.

I/R REMOTE CONTROL



The infrared ray remote control (item 392123) can be used to program the resident address book.

As well as the keys indicating letters and numbers, there are other keys for special programming functions:

- **NEXT MESS** selection next/previous messages
- **SHIFT** modifies the function of the NEXT MESSAGE and all the keys with double meaning
- **RESET** quits the editing phase losing each new setting
- **MEMORY** saves the new datum or the new selection
- **BACK** moves left by one position
- **SPACE** moves right by one position
- **SHIFT + " . "** enters a space (press *SHIFT* then " . ")

PROGRAMMING

ACCESS TO THE PROGRAMMING

Access to the Graphic Distribution board programming is protected by a Secret Code (Factory **1234**).

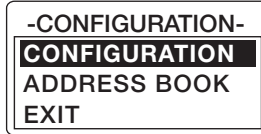

Once in Programming mode one can select:

- CONFIGURATION – to enter the device configuration menu.
- ADDRESS BOOK – to enter the address book configuration menu.
- QUIT – to quit the programming and go back to the initial page.

PUSHBUTTONS AND THEIR FUNCTIONS

-  • Moves the cursor right one figure (*short press*)
- Confirms and saves (*long 2-second press*)

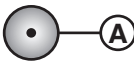
-  • Scrolls by one position ▲ (*short press*)
- One unit increase (*short press*)

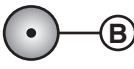
-  • Scrolls by one position ▼ (*short press*)
- One unit decrease (*short press*)

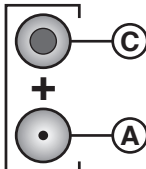
-  • Press pushbuttons **C + A** together to move the cursor one figure to the left (*typically first C and then A*)

PROGRAMMING

To access the programming:



- press the pushbutton for at least 10 seconds;

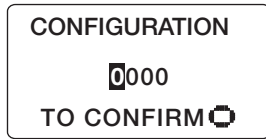

- use the pushbuttons to enter the secret code (e.g.:1234 Factory code);

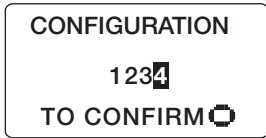

- press the pushbutton for at least 2 seconds to confirm;



If the code is correct:

- the programming is accessed;

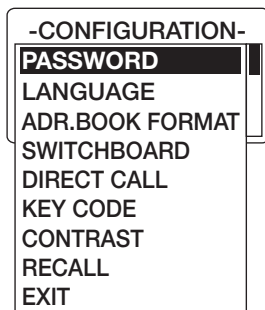

- otherwise the display goes back to the initial page.

PROGRAMMING**CONFIGURATION MENU**

This menu can configure:

- SECRET CODE – the secret programming access code.
- LANGUAGE – the menu display language.
- ADDRESS BOOK FORMAT – the address book format (alphanumeric/code).
- DISTRIBUTION BOARD – the distribution board call screen.
- DIRECT CALL – the direct call to two privileged extensions screen.
- DOOR CODE – the door opening code (max. 5 different codes).
- CONTRAST – the display contrast value (30 to 70)
- RECALL – the automatic recall tone (each 10 seconds for 4 times)

PROGRAMMING

SECRET CODE

To modify the programming access code (Factory **1234**):

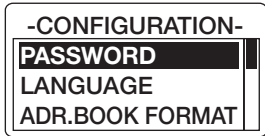

- Select **Secret Code**;

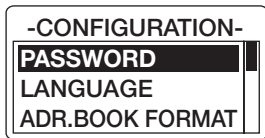

- press the pushbutton to confirm;

The secret code in use is shown on the display

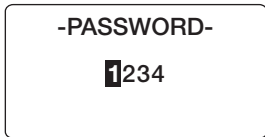

- enter the new code by means of the pushbuttons (e.g. 2244);

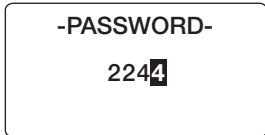

- keep the pushbutton pressed for 2 seconds to save the new code.

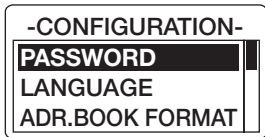

The display shows the initial page



If there are more than 7 seconds between pressing one pushbutton and the next, the display returns to the rest position, keeping the old secret code set.

PROGRAMMING

LANGUAGE

To modify the device language (*Factory Italian*):

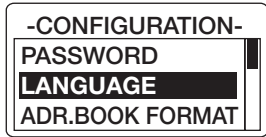

- Select **Language**;

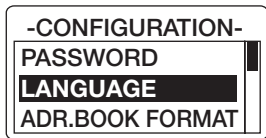

- press the pushbutton to confirm;



The language in use is shown on the display



- select the language required by means of the pushbuttons (e.g. English);



- press the pushbutton to confirm the new language.

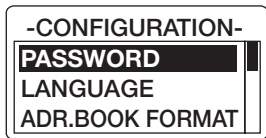

The display shows the initial page in the new language set.



The "Custom" language can be replaced with a predefined language using the TiCall software.

PROGRAMMING

ADDRESS BOOK FORMAT

To modify the device address book format (Factory alphanumeric without message):

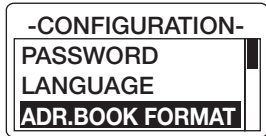

- Select Address book Format;

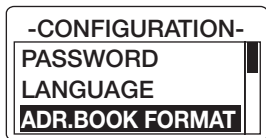

- press the pushbutton to confirm;

The format in use is shown on the display

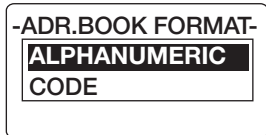

- select the new format* required by means of the pushbuttons;

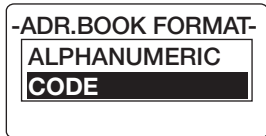

- press the pushbutton to confirm. 

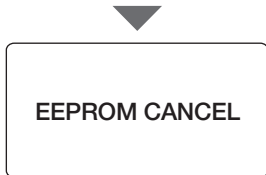

Modifying or confirming the “Address book format” in use cancels all the data in the resident address book.

(* The possible choices are:

ALPHANUMERIC:

- without message: max 1000 residents (surname + name)
- with message: max 500 residents (surname + name + message)

CODE: max 5000 residents (code)

PROGRAMMING

DISTRIBUTION BOARD

To enable the distribution board call screen:

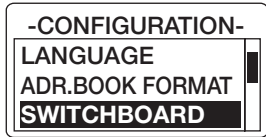

- Select **Distribution board**

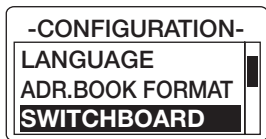

- Press the pushbutton to confirm;

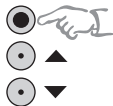
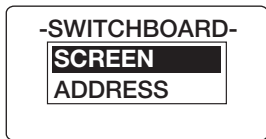

- Use the pushbuttons to select:
 - **Screen** to enable/disable the distribution board call screen (default: disabled)
 - **Address** to set the distribution board MN address (default: 4000)
- Confirm the choice;

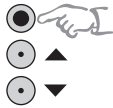
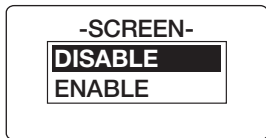

- Use the keys to select the choice required and confirm.



When the distribution board call screen is enabled, this is shown in succession every 10 seconds, alternating with the rest screen.

PROGRAMMING

DIRECT CALL

To enable the direct call to two privileged extensions screen:



- Select **Direct call**



- press the pushbutton to confirm;

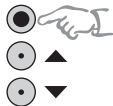
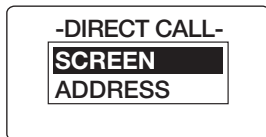

- use the pushbuttons to select:
 - **Screen** to enable/disable the direct call to two privileged extensions screen (default: disabled)
 - **Address** to set the MN address of the privileged extensions (Factory: 0000 and 0001)
- Confirm the choice;

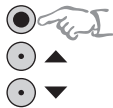
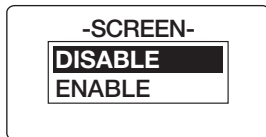

- Use the keys to select the choice required and confirm;

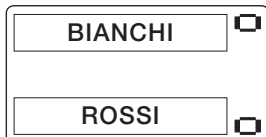

When the direct call screen is enabled, it is shown in succession every 10 seconds, alternating with the rest screen.



This function can only be enabled if the Address book format has been configured with Alphanumeric.

PROGRAMMING

DOOR CODE

This function can program up to 5 different door-opening codes (Factory 1234, 1235, 1236, 1237 and 1238).

To modify the door opening code:

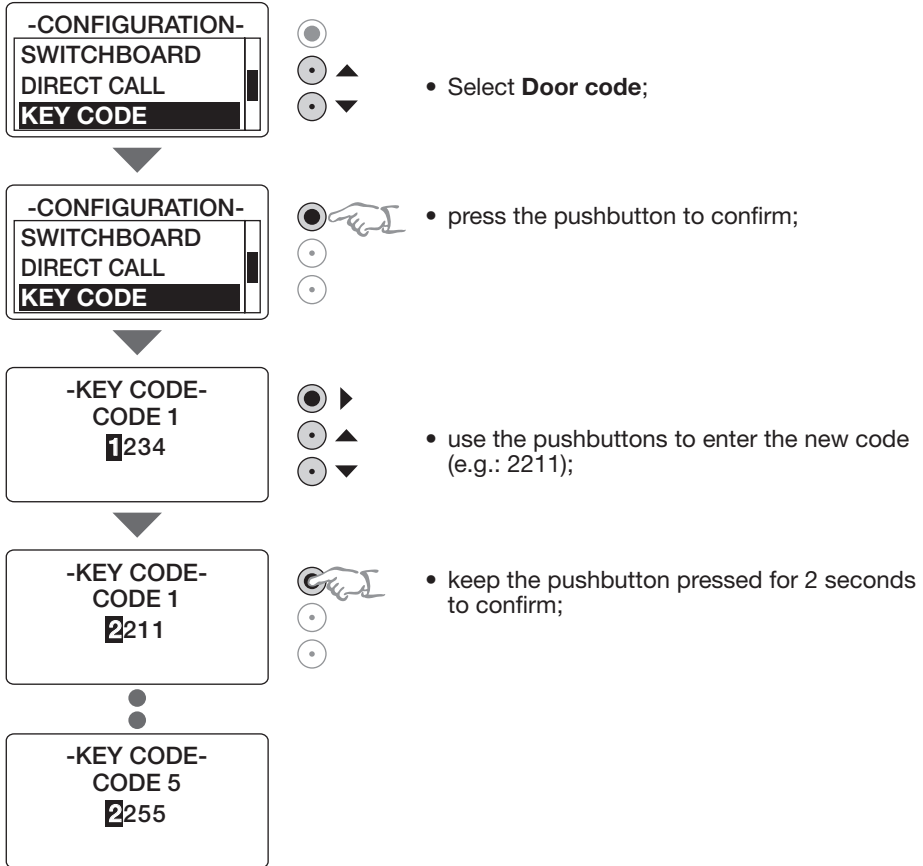

Example: Assigning the **door codes** with the following logic:

- CODE 1** - residents
- CODE 2** - monitoring service
- CODE 3** - maintenance service
- CODE 4** - postman
- CODE 5** - water and gas service

one assigned code (e.g. postman) can be changed without altering the others.

PROGRAMMING

CONTRAST

To modify the display contrast value (Factory – 70):

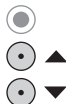
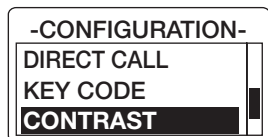

- Select **Contrast**;

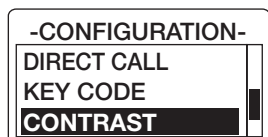

- press the pushbutton to confirm;

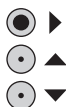
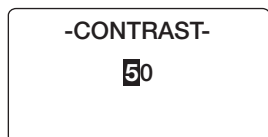

- use the pushbuttons to enter the new value (between 30 and 90);

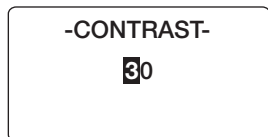

- keep the pushbutton pressed for 2 seconds to confirm.

PROGRAMMING

RECALL

To enable the display recall tone, 10 seconds for four times (Factory – **disabled**):

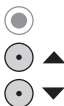
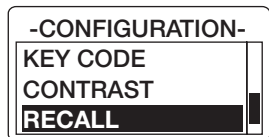

- Select **Recall**;

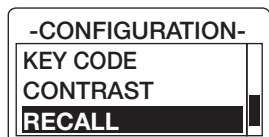

- press the pushbutton to confirm;

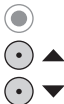
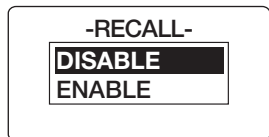

- select the choice required;

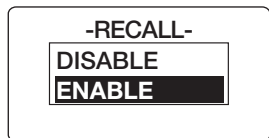

- keep the pushbutton pressed to confirm.

PROGRAMMING

ADDRESS BOOK MENU

In this menu new residents can be entered in the address book and the data entered can be modified or cancelled.

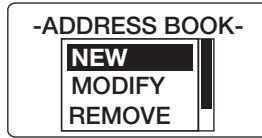

The menus vary depending on whether Alphanumeric or Code has been set in the "Address book format".

To access the address book menu:

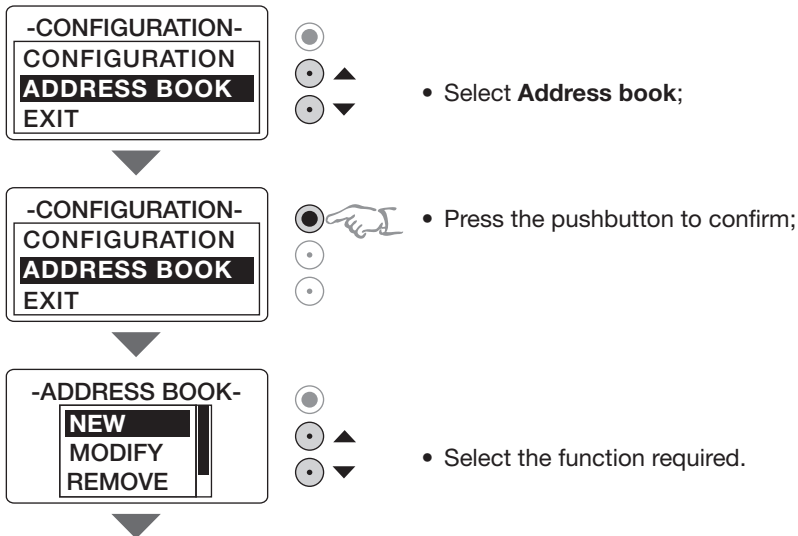

PROGRAMMING

New (Alphanumeric)

To enter a new resident in the address book:

-ADDRESS BOOK-
NEW
 MODIFY
 REMOVE



- Press the pushbutton to confirm;

-NEW-
 SURNAME:
 |

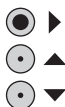

- Use the pushbuttons to enter the new data:
 - SURNAME
 - NAME
 - MESSAGE (if Alphanumeric with message)
 - MN ADDRESS

-NUOVO-
 SURNAME:
 BAI
 NAME:
 |



- press the pushbutton for 2 seconds to save each of these.

-NEW-
 ADDRESS MN:
 0012



RESIDENT INSERTED
 RESIDENTS NUMBER
 0001

PROGRAMMING

Modify (Alphanumeric)

To modify the data of a resident in the address book:

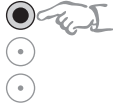
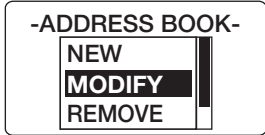

- Press the pushbutton to confirm;

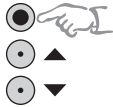
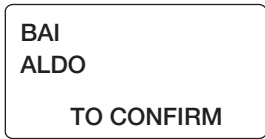

- use the pushbuttons to select the resident to be modified and confirm:

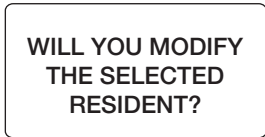

- press the pushbutton to confirm;

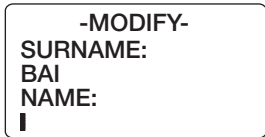

- use the pushbuttons to enter the new data:
 - SURNAME
 - NAME
 - MESSAGE (if Alphanumeric with message)
 - MN ADDRESS

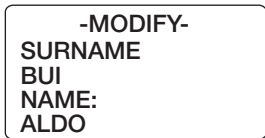

- press the pushbutton for 2 seconds to confirm each of these, even if they have not been modified.

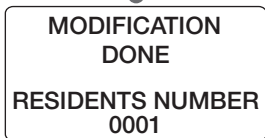

PROGRAMMING

Cancel (Alphanumeric)

To cancel a resident from the address book:

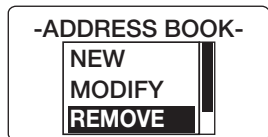

• Press the pushbutton to confirm;

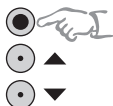
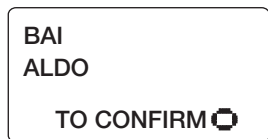

• use the pushbuttons to select the resident to be cancelled from the address book and confirm;

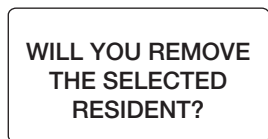

• press the pushbutton to confirm.

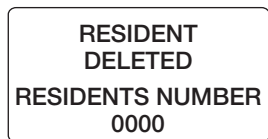

PROGRAMMING

New (Code)

To enter a new resident in the address book:

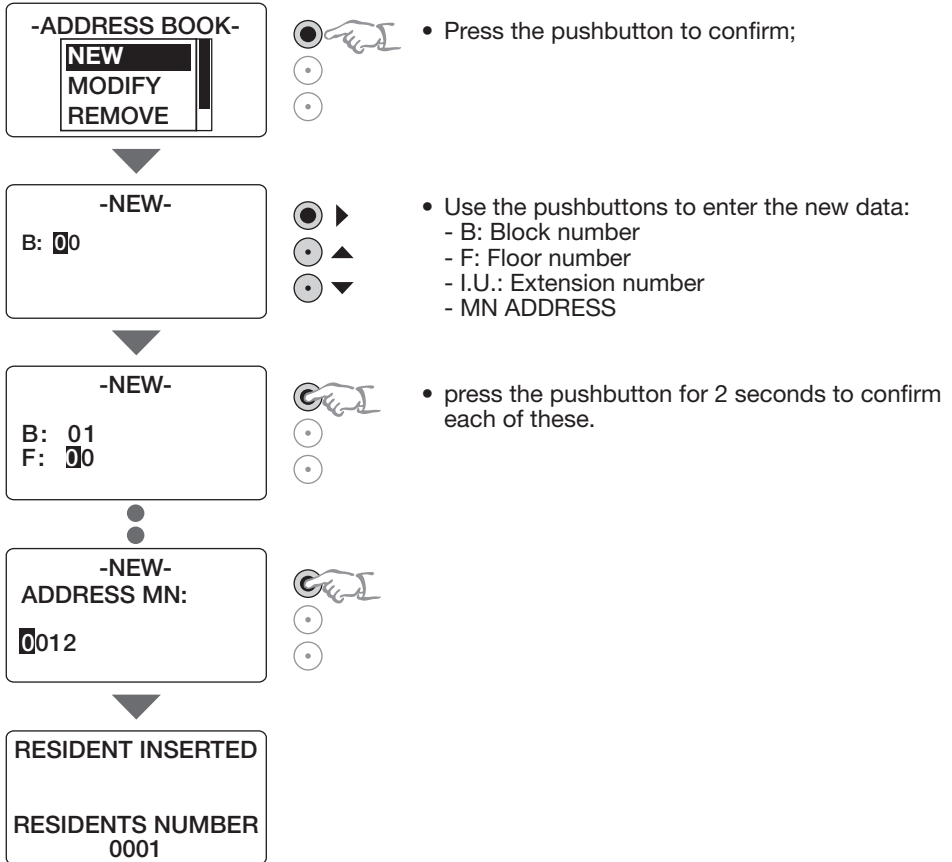

PROGRAMMING

Modify (Code)

To modify the data of a new resident in the address book:

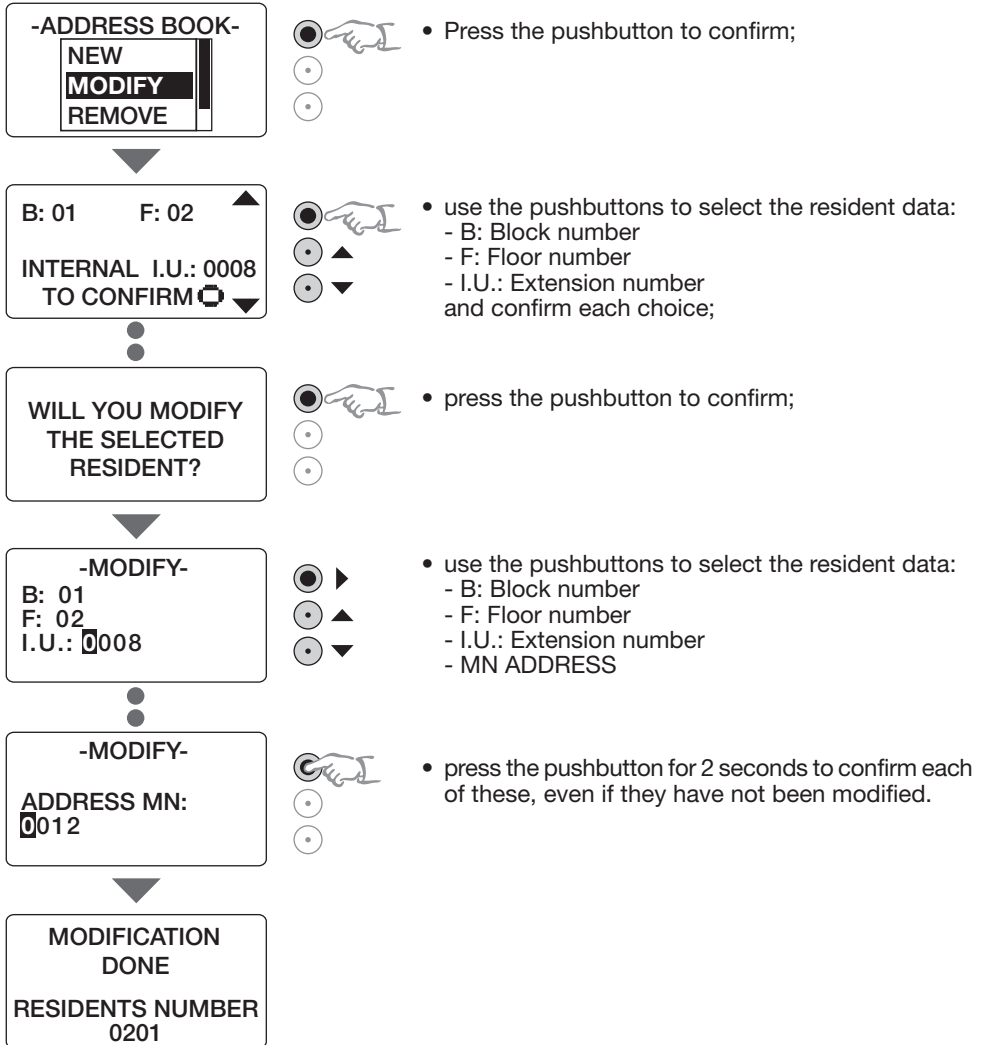

PROGRAMMING

Cancel (Code)

To cancel a new resident in the address book:

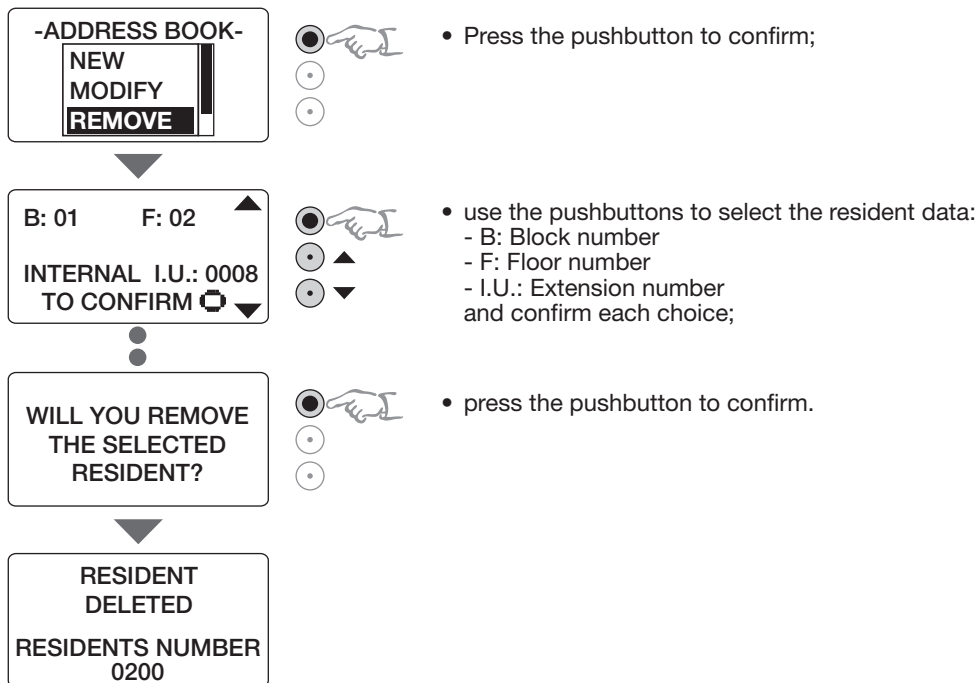

TICALL SOFTWARE

The TiCall software can program all the parameters in the device configuration menu, using a PC with Microsoft operating system.

The functions described above can be programmed when the device is already installed, by means of SCS bus, or before installation (just power the speaker module), connecting it to the PC RS232 port by means of the serial interface cable (item 335919). To transfer the programming the module display must show the initial page (rest position). By assigning a name to each custom programming, the filing can be managed like any other file.

The software can also update the device firmware and replace the “Custom” language with a predefined language by means of the serial interface cable (item 335919).

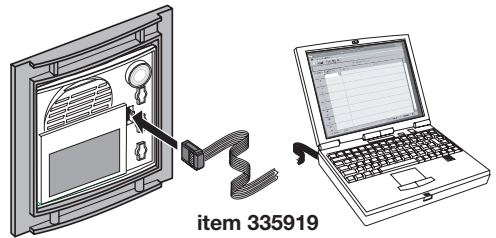

CONFIGURATION

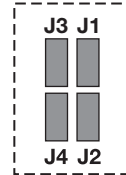
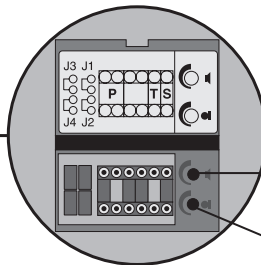
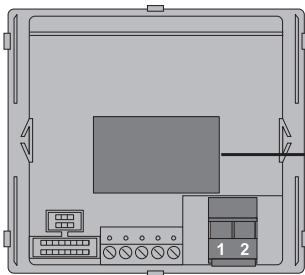

Loudspeaker volume adjustment

Microphone sensitivity adjustment

P - entrance panel number

The configurator inserted in socket P of the speaker module assigns it a recognition number inside the system.

The main entrance panel must not be configured in P, while all the other entrance panels must be numbered progressively.

T - door lock relay timing

configurator number							
0 = No configurator	1	2	3	4	5	6	7
4 sec.	1 sec.	2 sec.	3 sec.	as pushbutton	6 sec.	8 sec.	10 sec.

S - type of call signal

The configuration of S determines the tone of the internal unit call. The calls from different entrance panels can thus be differentiated.

Configurator	0	1	2	3
Type of ring tone	Two-tone	Two-tone	Two-tone	one-tone
	1200 Hz	1200 Hz	1200 Hz	1200 Hz
	600 Hz	0 Hz	2400 Hz	

J4 - confirm call on EP

Remove jumper J4 to eliminate the call tone on the entrance panel.

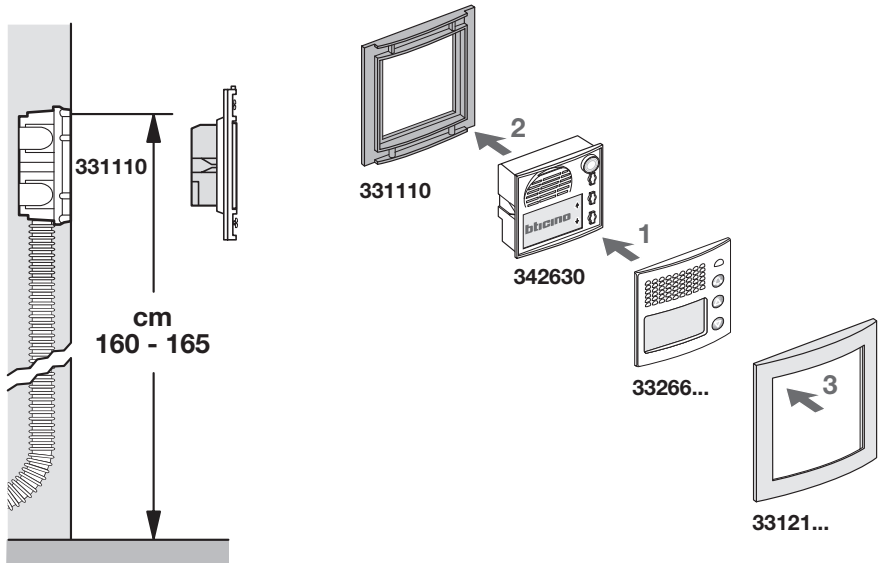
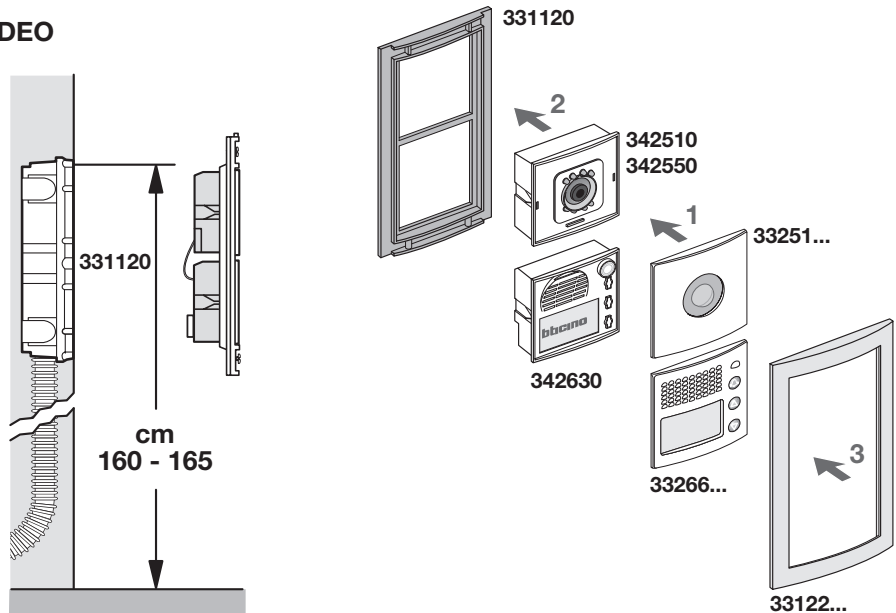
INSTALLATION**AUDIO****VIDEO**

INSTALLATION

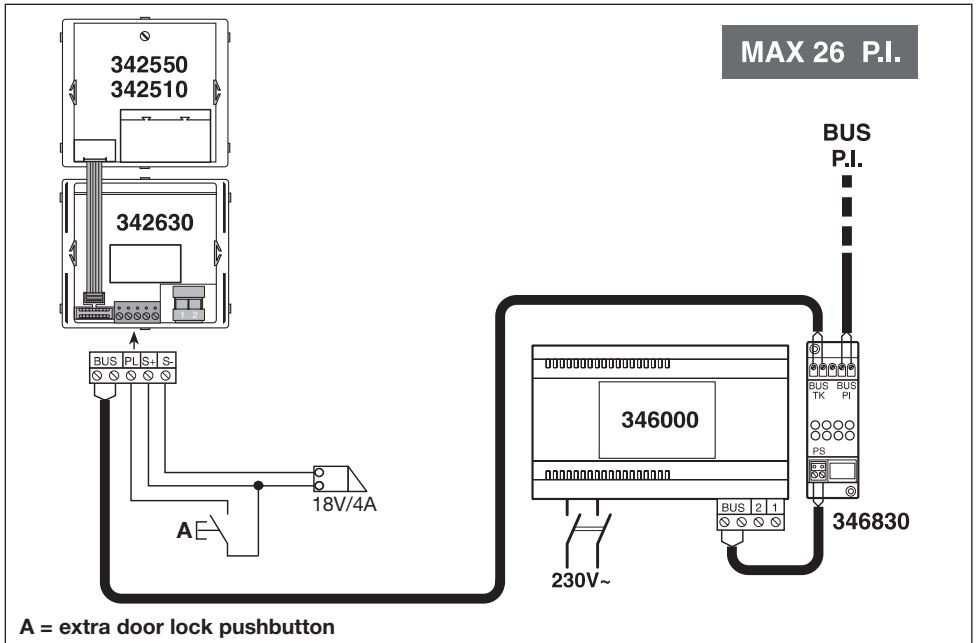
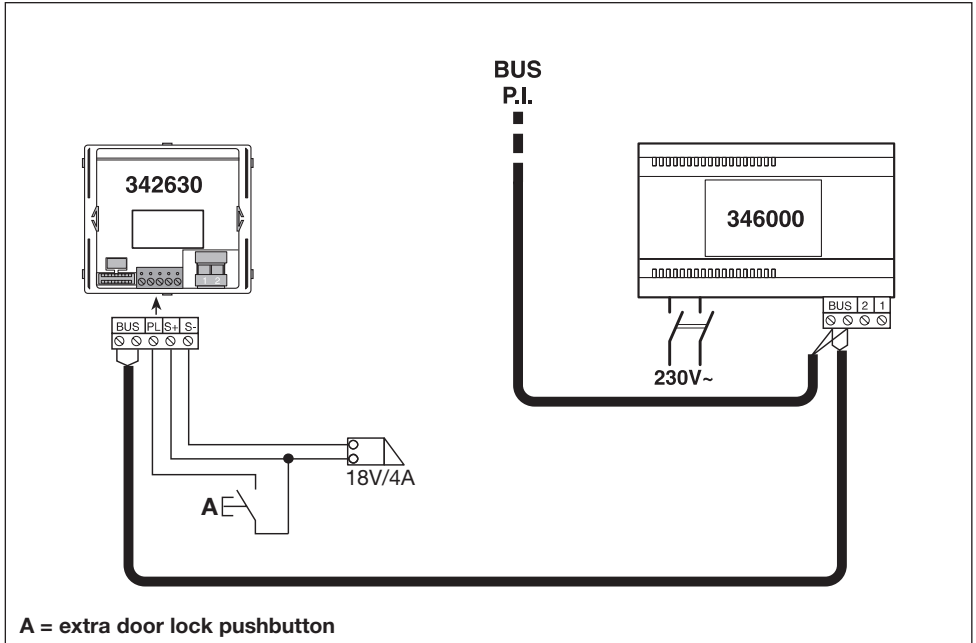

INSTALLATION

MAX 64 P.I.

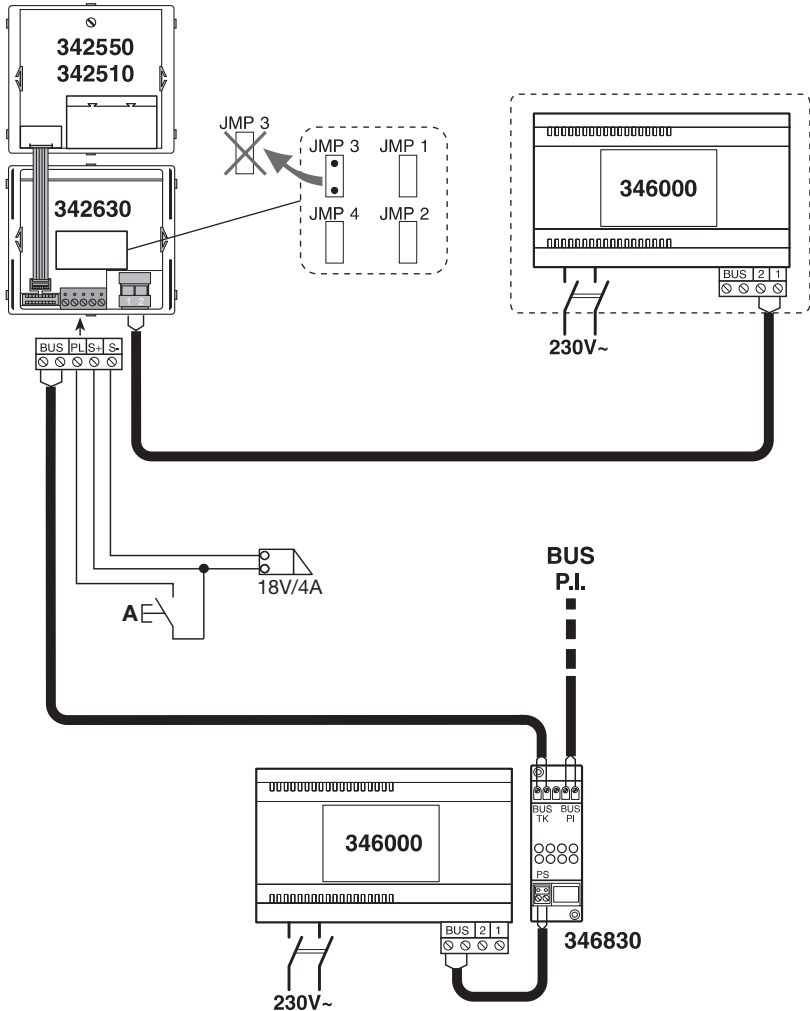

A = extra door lock pushbutton



A series of horizontal dotted lines spanning the width of the page, providing a guide for handwriting practice.

ÍNDICE

INTRODUCCIÓN	94
Advertencias y consejos	94
Descripción general	94
Display gráfico	95
Pulsadores y funciones	95
Configuración predeterminada	96
Reajuste de la configuración predeterminada	96
USO	97
Búsqueda de un residente del cual se conoce el nombre	97
Búsqueda de un residente del cual se conoce el código	98
DISPOSITIVOS ADICIONALES EXTERIORES	99
Módulo teclado adicional	99
Telemando I/R	99
PROGRAMACIÓN	100
Acceso a la programación	100
Pulsadores y funciones	100
Menú configuración	102
Código secreto	103
Idioma	104
Formato agenda	105
Centralita	106
Llamada directa	107
Código puerta	108
Contraste	109
Rellamada	110
Menú agenda	111
SOFTWARE TICALL	118
CONFIGURACIÓN	118
INSTALACIÓN	119



Para cambiar el idioma en que se visualizan los menús:

- acceder al modo **Programación** descrito en la pág. 101;
- efectuar el procedimiento **Idioma** descrito en la pág. 104.

INTRODUCCIÓN

ADVERTENCIAS Y CONSEJOS

Antes de instalar el módulo es importante leer cuidadosamente el presente manual.



El fabricante declina toda responsabilidad por eventuales daños debidos a un uso incorrecto y/o no conforme a las instrucciones contenidas en el presente manual.

DESCRIPCIÓN GENERAL

El módulo vocal digital con display gráfico retroiluminado permite enviar la llamada a una placa interior, corriendo los nombres o los códigos de los residentes en el display por medio de las teclas correspondientes. El módulo puede memorizar un máximo de 1000 nombres y apellidos de residentes, asociándolos a la **dirección de configuración*** de la PI (Placa Interior) del sistema.

Los nombres se reducen a 500 si se asocia a los mismos también un mensaje. Si por motivos de confidencialidad decide guardar solamente los códigos de los residentes, es posible extender esta opción hasta 5000 códigos. Es posible asociar dos nombres diferentes a la misma dirección MN.

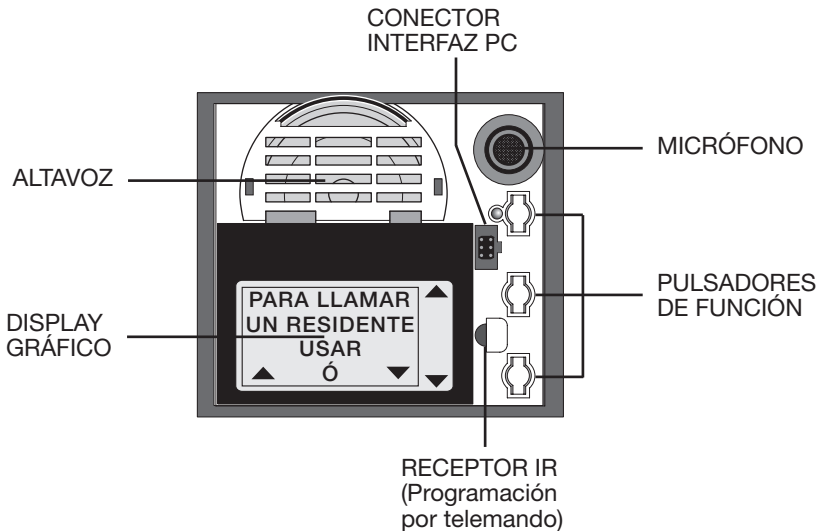

(*) En este manual se utilizará la abreviatura **MN** para indicar la “**Dirección de configuración**”

INTRODUCCIÓN

DISPLAY GRÁFICO

En posición de reposo, el display de la centralita gráfica visualiza la pantalla para llamar a un residente.



 Cuando están habilitadas las pantallas de llamada a la centralita y directa, éstas se visualizan cada 10 segundos alternadas a la pantalla de reposo.



PULSADORES Y FUNCIONES

Por medio de los tres pulsadores del módulo, es posible buscar en la agenda, visualizada en el display, el nombre o el código del residente y enviar la llamada.



- Llama al residente seleccionado



- Se corre a una posición anterior ▲ (presionando brevemente)
- Para correr rápidamente ▲ (mantener presionado 2 segundos)



- Se corre a una posición sucesiva ▼ (presionando brevemente)
- Para correr rápidamente ▼ (mantener presionado 2 segundos)



DESPLAZAMIENTO RÁPIDO: En el display se visualizan varios residentes por vez.

INTRODUCCIÓN

CONFIGURACIÓN PREDETERMINADA

Código secreto	1234
Idioma	Italiano
Formato Agenda	Alfanumérico sin mensaje
Centralita	4000 Deshabilitado
Llamada	0000 y 0001 Deshabilitado
Código puerta	1234, 1235, 1236, 1237 y 1238
Contraste	50
Rellamada	Deshabilitada

REAJUSTE DE LA CONFIGURACIÓN PREDETERMINADA

Para restablecer la Configuración predeterminada:

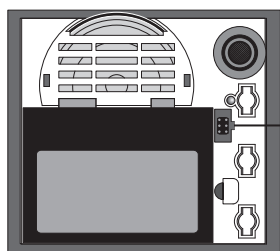

- Quitar la alimentación al dispositivo
- Insertar un puente en ambas agujas inferiores de la interfaz

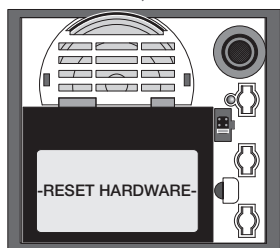

- Vuelva a alimentar el dispositivo, en el display se visualiza el mensaje sucesivo:
- RESET HARDWARE -
- Quitar la alimentación al dispositivo

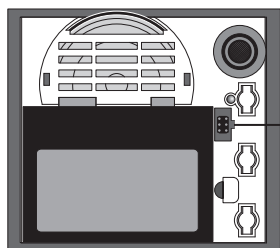

- Extraiga el puente
- Vuelva a alimentar el dispositivo, se restablece la configuración predeterminada.

USO

BÚSQUEDA DE UN RESIDENTE DEL CUAL SE CONOCE EL NOMBRE

Para llamar a un residente del cual se conoce el nombre:



- Presione un pulsador para acceder a la búsqueda;

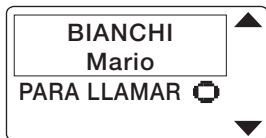

- corra la agenda hasta que aparezca en el display el nombre deseado;

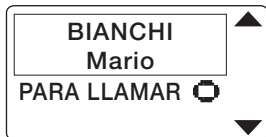

- presione el pulsador para enviar la llamada.

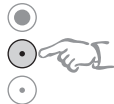
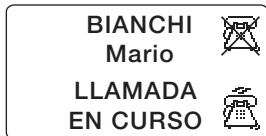

- Si el número llamado no contesta, es posible interrumpir la llamada, presionando el pulsador.

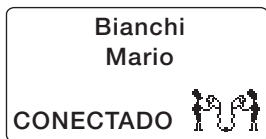

Quando el residente contesta el display señala que la conversación se está efectuando.



Quando el residente cuelga el auricular del interfono o al pasar 60 segundos, la comunicación se corta y el display regresa a la posición de reposo.



Este tipo de búsqueda es posible sólo si se ha establecido el Formato Agenda ALFANUMÉRICO.

USO

BÚSQUEDA DE UN RESIDENTE DEL CUAL SE CONOCE EL CÓDIGO

Para llamar a un residente del cual se conoce el código:



- Presione un pulsador para acceder a la búsqueda

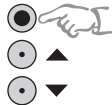

- Seleccione por medio de los pulsadores; el Bloque, la Planta y la Extensión deseada y confirme cada opción.

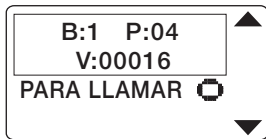

- Presione el pulsador para enviar la llamada

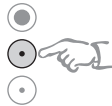
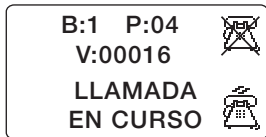

- Si el número llamado no contesta, es posible interrumpir la llamada, presionando el pulsador.

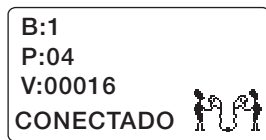

Quando el residente contesta el display señala que la conversación se está efectuando.

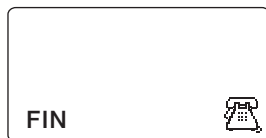

Quando el residente cuelga el auricular del interfono o al pasar 60 segundos, la comunicación se corta y el display regresa a la posición de reposo.



Este tipo de búsqueda es posible sólo si se ha establecido el Formato Agenda CÓDIGO. Los códigos se deben programar durante la instalación, asociando al residente un código identificativo: B (bloque), P (piso) e V (extensión).

DISPOSITIVOS ADICIONALES EXTERIORES

MÓDULO TECLADO ADICIONAL

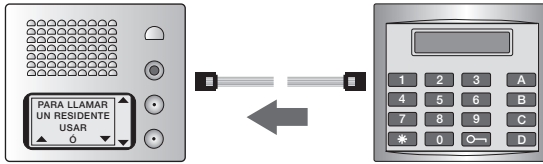

El módulo teclado (Art. 342640) permite:

- Llamar directamente al residente del cual se conoce el nombre (si se ha establecido el Formato Agenda ALFANUMÉRICO), marcando la dirección MN con el teclado.
- Llamar directamente al residente del cual se conoce el código (si se ha establecido el Formato Agenda CÓDIGO), marcando código (Bloque, Planta, Extensión) con el teclado.
- Abra la cerradura, presionando el pulsador  y marcando un código numérico.

El módulo teclado se suministra con un multicable para su conexión al módulo vocal.

TELEMANDO I/R



El telemando por infrarrojos (Art. 392123) se puede utilizar para programar la agenda de los residentes.

Además de las teclas que indican letras y números, existen otras teclas para asignar distintas funciones de programación:

- NEXT MESS selecciona la entrada sucesiva/anterior
- SHIFT cambia la función de NEXT MESS y de todas las teclas con doble significado
- RESET sale de la fase de edición perdiendo la nueva configuración
- MEMORY guarda el dato nuevo o la nueva selección
- BACK corre una posición hacia la izquierda
- SPACE corre una posición hacia la derecha
- SHIFT + “ . ” pone un espacio (presione SHIFT luego “ . ”)

PROGRAMACIÓN

ACCESO A LA PROGRAMACIÓN

El acceso a la programación de la Centralita Gráfica está protegida por un Código Secreto (predefinido **1234**).



Después de entrar al menú programación es posible seleccionar:

- CONFIGURACIÓN - para entrar a los menús de configuración del dispositivo.
- AGENDA - para entrar al menú de configuración de la agenda.
- SALIR - Para salir de la programación y regresar a la página inicial.

PULSADORES Y FUNCIONES



- Para mover una cifra a la derecha el cursor (*presionando brevemente*)
- Para confirmar y memorizar (*mantener presionado 2 segundos*)



- Para correr a una posición ▲ (*presionando brevemente*)
- Aumentar una unidad (*presionando brevemente*)



- Para correr a una posición ▼ (*presionando brevemente*)
- Bajar una unidad (*presionando brevemente*)

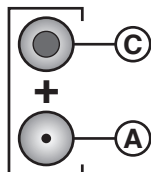

- Los pulsadores **C + A** presionados juntos corren el cursor una cifra a la izquierda (*es decir antes C y luego A*)

PROGRAMACIÓN

Para acceder a la programación:



- Mantenga presionado el pulsador al menos unos 10 segundos;

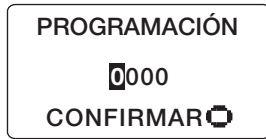

- marque con los pulsadores el código secreto (por ej. 1234 código de fábrica);

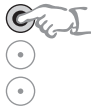

- mantenga presionando el pulsador al menos unos 2 segundos para confirmar.



Si el código es incorrecto:

- se accede a la Programación

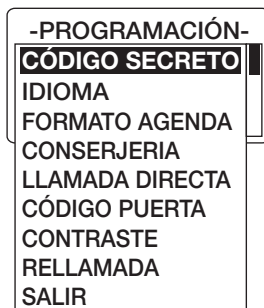

- de lo contrario se regresa a la página inicial

PROGRAMACIÓN**MENÚ CONFIGURACIÓN**

En este menú se pueden configurar:

- **CÓDIGO SECRETO** - es la contraseña para acceder a la programación.
- **IDIOMA** - el idioma en que se visualizan los menús.
- **FORMATO AGENDA** - el formato de la agenda (alfanumérico/código).
- **CENTRALITA** - la pantalla de llamada a la centralita.
- **LLAMADA DIRECTA** - la pantalla de llamada directa a dos extensiones preferenciales.
- **CÓDIGO PUERTA** - el código de apertura de la puerta (máx. 5 códigos diferentes).
- **CONTRASTE** - el valor de contraste del display (30-70).
- **RELLAMADA** - el tono de rellamada automática (cada 10 segundos por 4 veces).

PROGRAMACIÓN

CÓDIGO SECRETO

Para cambiar el código de acceso a la programación (predefinido **1234**):

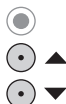
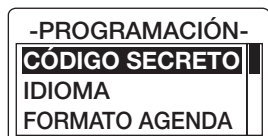

- Seleccione **Código Secreto**;

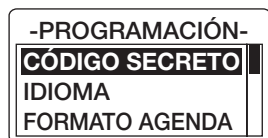

- presione el pulsador para confirmar;

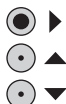

- teclee por medio de los pulsadores el nuevo código (por ej. 2244);



- mantenga presionado 2 segundos el pulsador para guardar el nuevo código.



En el display se visualiza la página inicial



Al cabo de 7 segundos entre la última presión de un pulsador, el display regresa a la posición de reposo, manteniendo programado el viejo código secreto.

PROGRAMACIÓN

IDIOMA

Para cambiar el idioma del dispositivo (predefinido - **Italiano**):

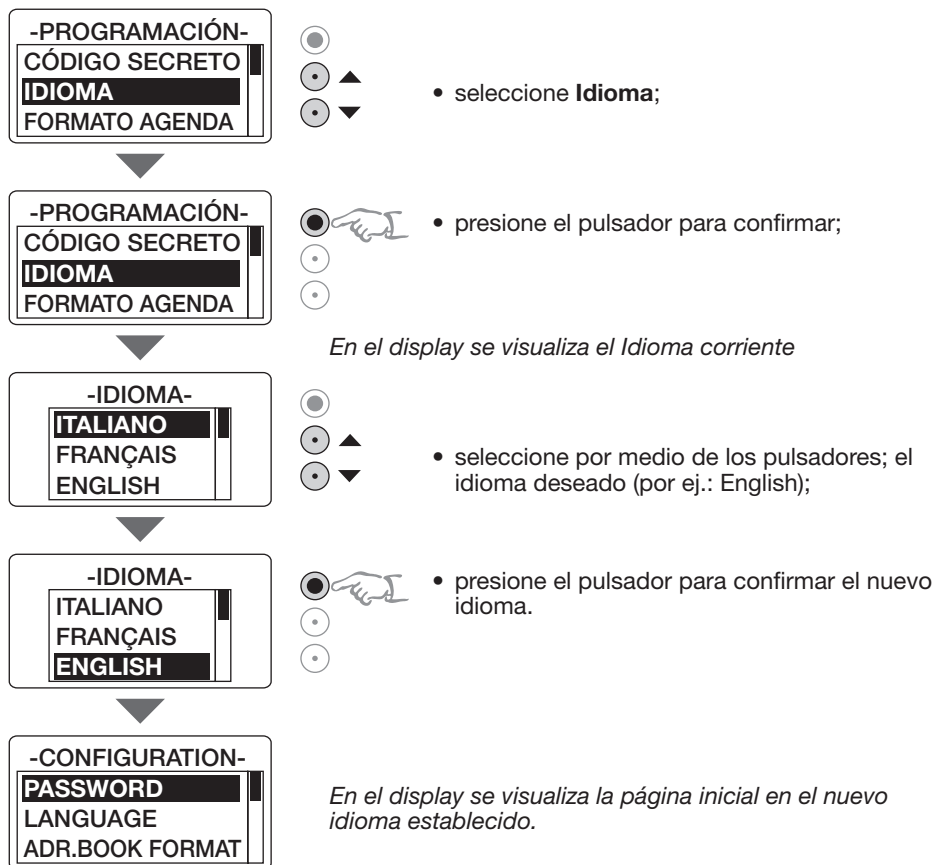

Es posible personalizar el idioma con uno de los idiomas predefinidos por medio del Software TiCall.

PROGRAMACIÓN

FORMATO AGENDA

Para cambiar el formato de la agenda del dispositivo (predefinido - **alfanumérico sin mensaje**):



- seleccione **Formato Agenda**



- presione el pulsador para confirmar



En el display se visualiza el siguiente mensaje

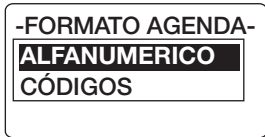

- seleccione por medio de los pulsadores el nuevo formato*;



- presione el pulsador para confirmar 

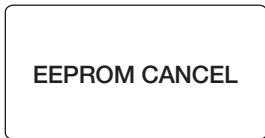

El cambio o la confirmación del “Formato agenda” utilizado borra todos los datos contenidos en la agenda de los residentes.

(* Las elecciones posibles son:

ALFANUMÉRICO:

- sin mensaje: máx **1000** residentes (apellido+nombre)
- con mensaje: máx **500** residentes (apellido+nombre+mensaje)

CÓDIGO: máx **5000** residentes (código)

PROGRAMACIÓN

CENTRALITA

Para habilitar la pantalla de llamada a la centralita:



- seleccione **Centralita**

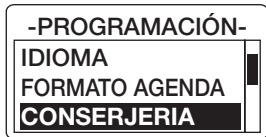

- presione el pulsador para confirmar

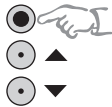

- seleccione por medio de los pulsadores:
 - **Pantalla** para habilitar/deshabilitar la pantalla de llamada a la centralita (configuración predefinida: deshabilitada)
 - **Dirección** para establecer la dirección MN de la centralita (configuración predefinida: 4000)
- confirma la elección

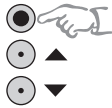
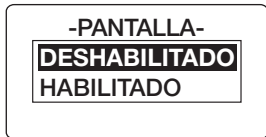

- seleccione por medio de los botones la opción deseada y confirme

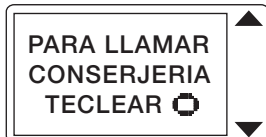

Cuando está habilitada la pantalla de llamada a la centralita y directa, ésta se visualiza cada 10 segundos alternadas a la pantalla de reposo.

PROGRAMACIÓN

LLAMADA DIRECTA

Para habilitar la pantalla de llamada directa a dos extensiones preferenciales:

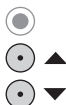
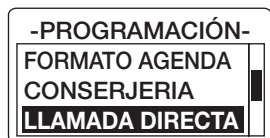

- seleccione **Llamada Directa**;

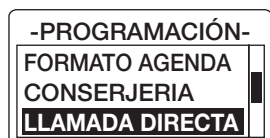

- presione el pulsador para confirmar;

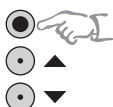

- seleccione por medio de los pulsadores:
 - **Pantalla** para habilitar/deshabilitar la pantalla de llamada directa a dos extensiones preferenciales (configuración predeterminada: deshabilitada)
 - **Dirección** para establecer la dirección MN de las extensiones preferenciales (configuración predeterminada: 0000 y 0001)
- confirma la elección;

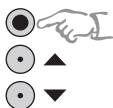
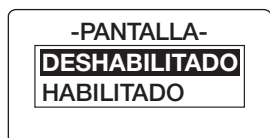

- seleccione por medio de los botones la opción deseada y confirme.

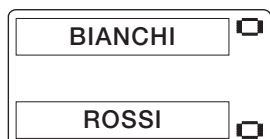

Cuando se habilita la pantalla de llamada directa a la centralita, ésta se visualiza cada 10 segundos alternada a la pantalla de reposo.



Es posible habilitar esta función sólo si se ha configurado el Formato Agenda Alfanumérico.

PROGRAMACIÓN

CÓDIGO PUERTA

Esta función permite programar un máximo de 5 códigos de apertura de la puerta (configuración predeterminada 1234, 1235, 1236, 1237, 1238).

Para modificar el código de apertura de la puerta:

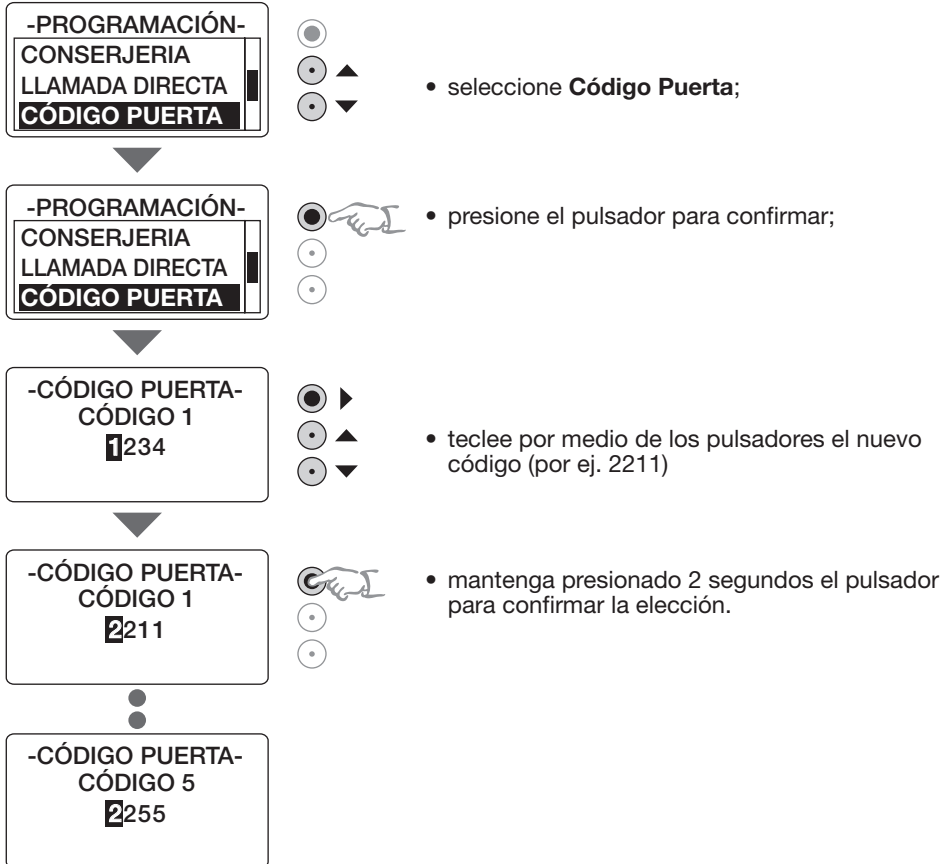

Ejemplo: Asignando los **códigos de la puerta** con la siguiente lógica:

- CÓDIGO 1** - residentes
- CÓDIGO 2** - servicio de vigilancia
- CÓDIGO 3** - servicio de mantenimiento
- CÓDIGO 4** - cartero
- CÓDIGO 5** - servicio agua y gas

será posible modificar un código asignado (por ej. cartero) manteniendo los demás.

PROGRAMACIÓN

CONTRASTE

Para modificar el valor de contraste del display (configuración predefinida **70**):

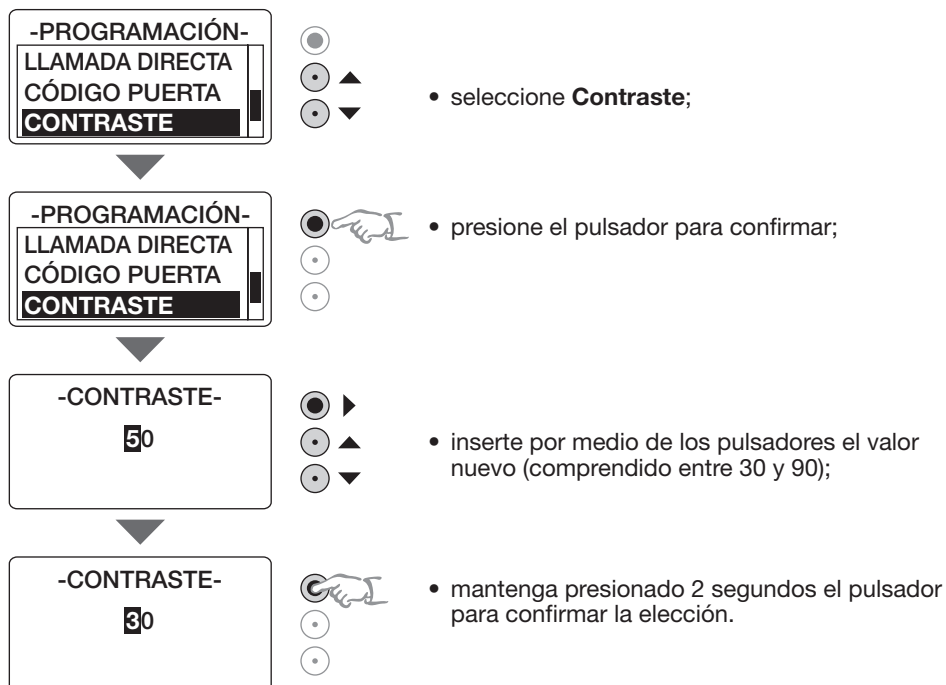

PROGRAMACIÓN

RELLAMADA

Para habilitar el tono de rellamada automática, 10 segundos por cuatro veces (configuración predefinida **deshabilitada**):

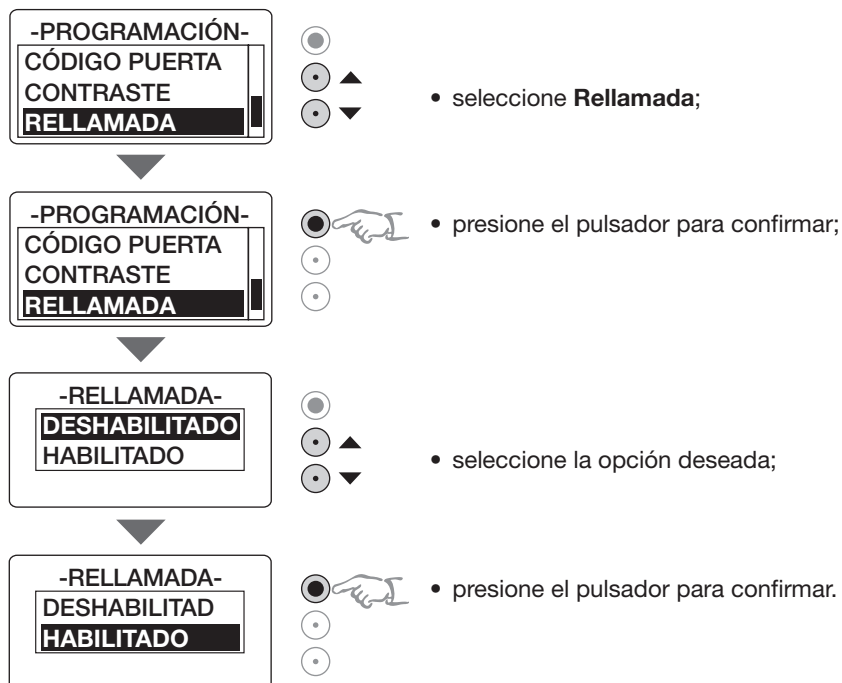

PROGRAMACIÓN

MENÚ AGENDA

En este menú se pueden insertar en la agenda nuevos residentes, modificar los datos insertados o borrarlos.



Los menús varían en función del "Formato Agenda" establecido Alfanumérico o Código.

Para acceder al menú agenda:

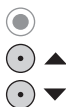
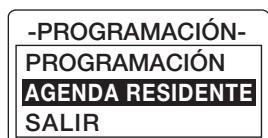

• seleccione **Agenda**

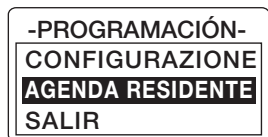

• presione el pulsador para confirmar

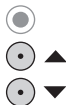

• seleccione la función deseada

PROGRAMACIÓN

Nuevo (Alfanumérico)

Para insertar un nuevo residente en la agenda:

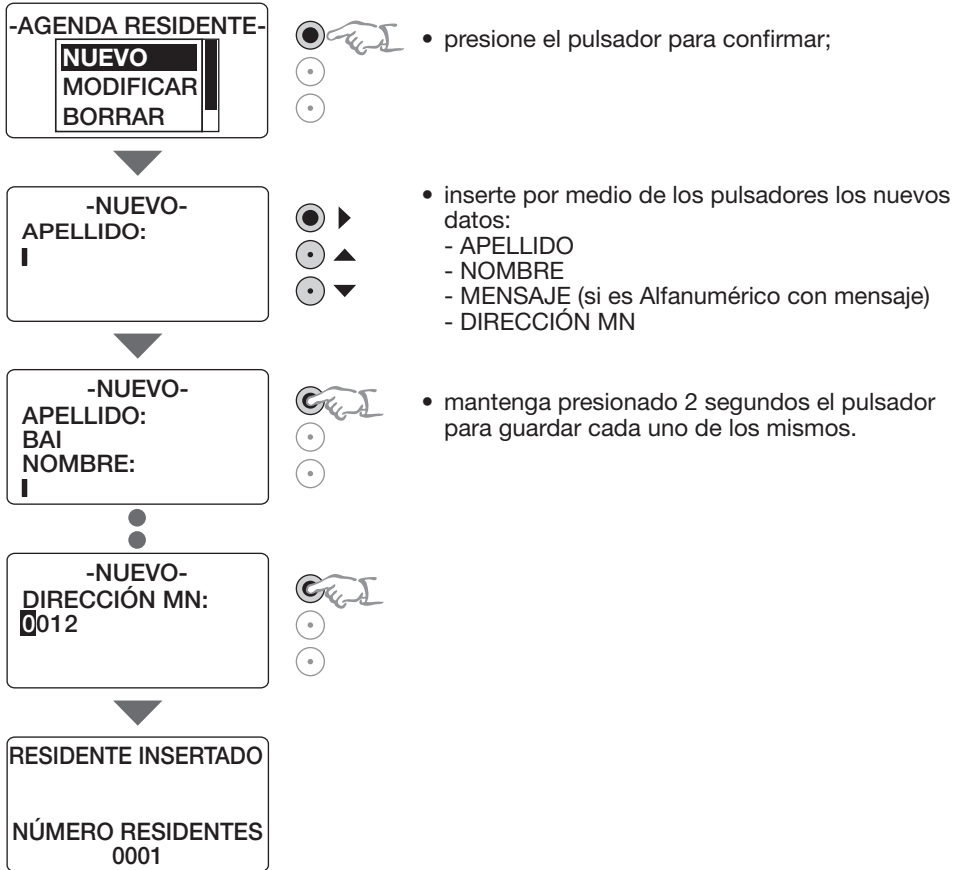

PROGRAMACIÓN

Cambiar (Alfanumérico)

Para modificar los datos de un residente presente en la agenda:

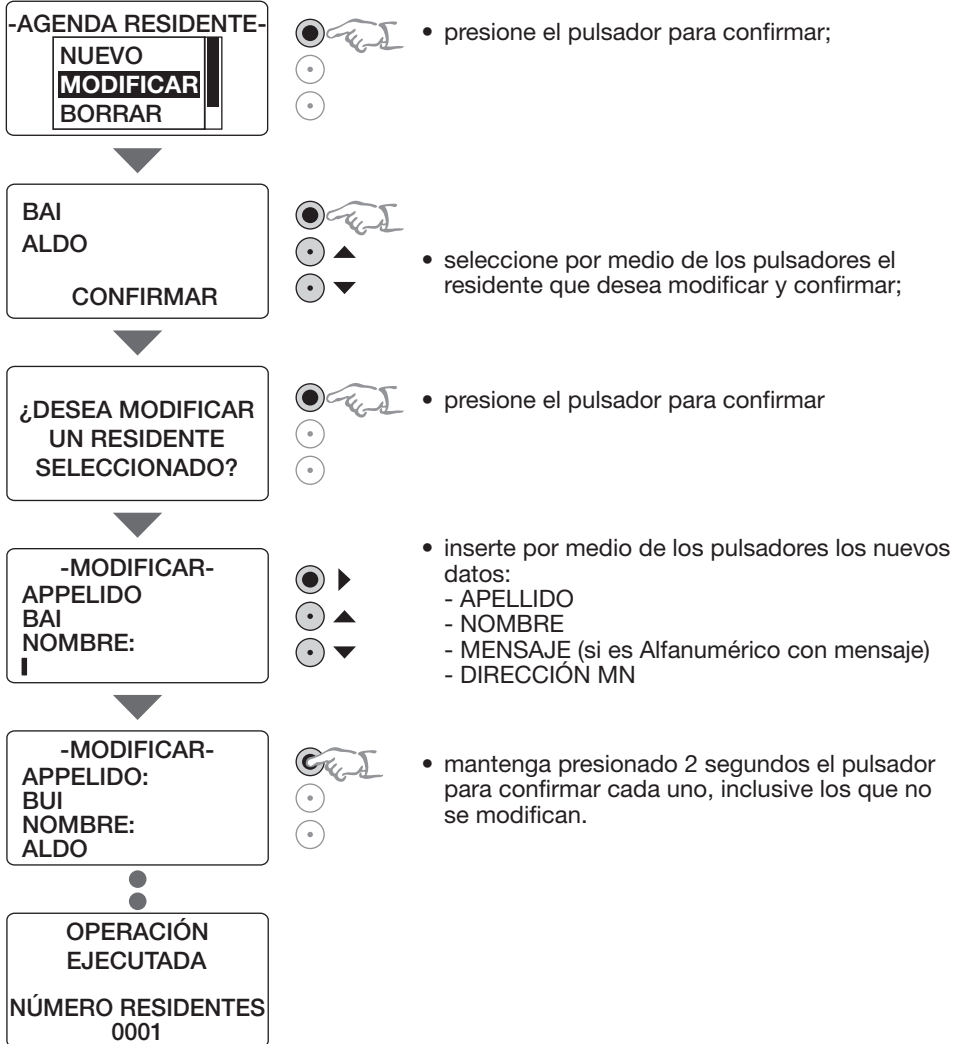

PROGRAMACIÓN

Borrar (Alfanumérico)

Para borrar un residente de la agenda:

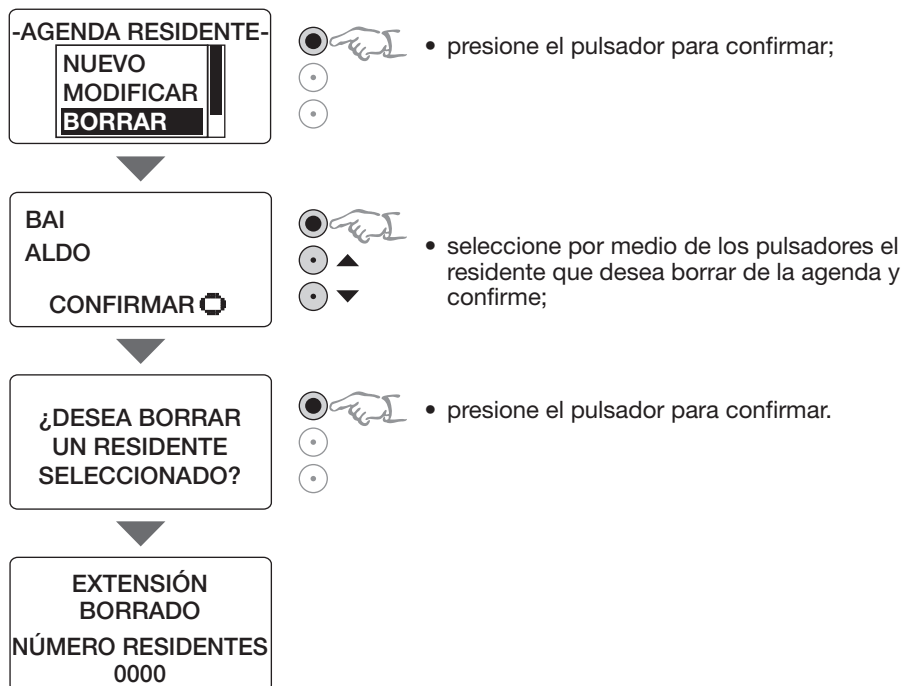

PROGRAMACIÓN

Nuevo (Código)

Para insertar un nuevo residente en la agenda:

-AGENDA RESIDENTE-

NUEVO
MODIFICAR
BORRAR



- presione el pulsador para confirmar;



-NUEVO-

B: 00



- inserte por medio de los pulsadores los nuevos datos:
 - B: número de Bloque
 - P: número de Planta
 - V: número de Extensión
 - DIRECCIÓN MN



-NUEVO-

B: 01
P: 00

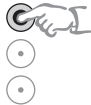

- mantenga presionado 2 segundos el pulsador para guardar cada uno de los mismos.



-NUEVO-
DIRECCIÓN MN:

0012



RESIDENTE INSERTADO

NÚMERO RESIDENTES
0001

PROGRAMACIÓN

Cambiar (Código)

Para modificar los datos de un residente presente en la agenda:

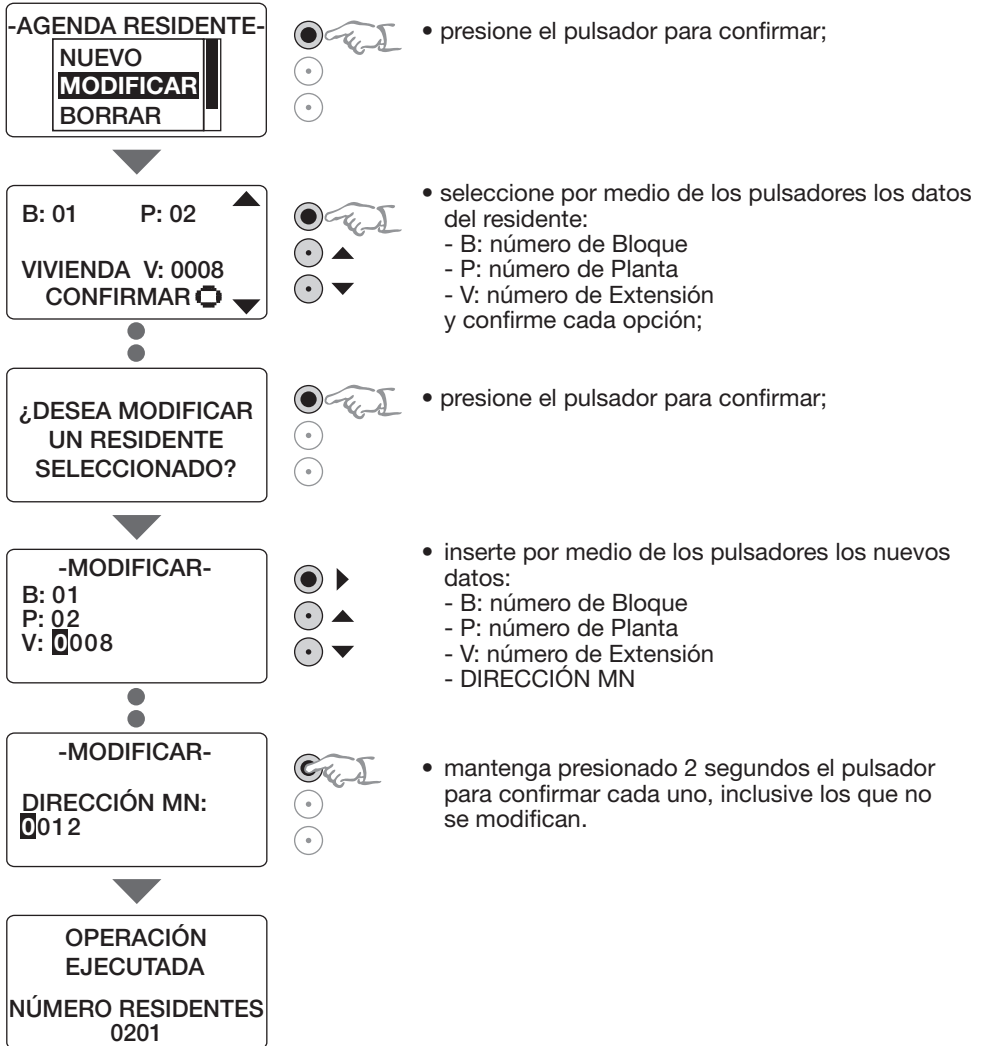

PROGRAMACIÓN

Borrar (Código)

para borrar un residente presente en la agenda:

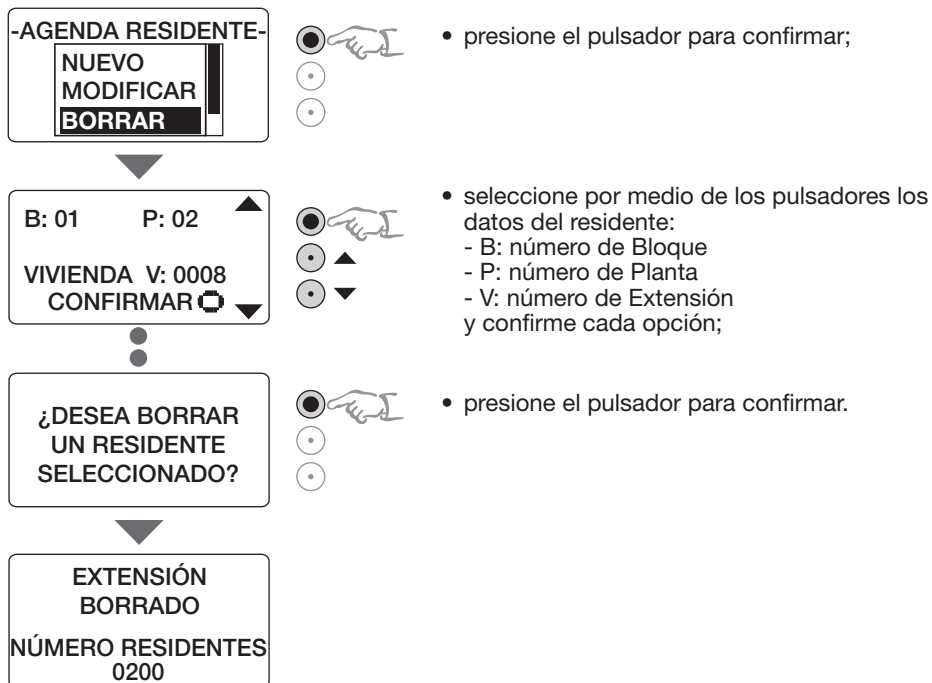

SOFTWARE TICALL

El software TICALL permite programar todos los parámetros presentes en los menús de configuración del dispositivo, mediante un PC con Sistema operativo Microsoft.

La programación de las funciones arriba descritas se puede efectuar con el dispositivo ya instalado por medio de un Bus SCS o antes de la instalación (es suficiente alimentar el módulo vocal), conectándolo al puerto RS232 del PC por medio del cable de interfaz serial (Art. 335919). Para transferir la programación el display del módulo debe visualizar la página inicial (posición de reposo).

Asignando a cada programación personalizada un nombre, será posible almacenarla como cualquier archivo.

El software permite actualizar el firmware del dispositivo y personalizar el idioma, cambiándolo con uno de los idiomas predefinidos por medio del cable de interfaz serial (Art. 335919).

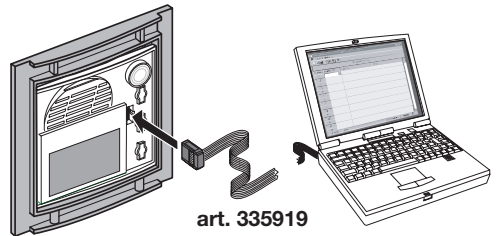

CONFIGURACIÓN

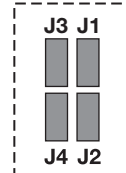
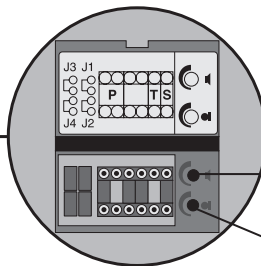
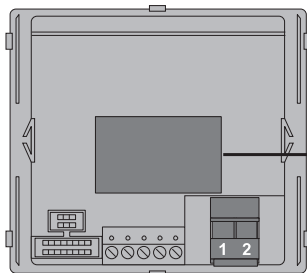

Ajuste volumen altavoz

Ajuste sensibilidad micrófono

P - número de placa exterior

El configurador activado en el espacio P del módulo vocal, asigna a éste un número de reconocimiento en el sistema.

La placa exterior principal no debe estar configurado en P, mientras que las demás placas exteriores deben estar enumerados en modo progresivo.

T - Temporización relé cerradura

número del configurador							
0= Ninguno configurador	1	2	3	4	5	6	7
4 seg.	1 seg.	2 seg.	3 seg.	como pulsador	6 seg.	8 seg.	10 seg.

S - tipo de señal de llamada

La configuración de S determina el tono de la llamada de las placas interiores. De esta manera es posible diferenciar las llamadas procedentes de placas exteriores diferentes.

Configurador	0	1	2	3
Tipo de timbre	Bitonal	Bitonal	Bitonal	Monotonal
	1200 Hz	1200 Hz	1200 Hz	1200 Hz
	600 Hz	0 Hz	2400 Hz	

J4 - confirmar llamada en la placa exterior

Para eliminar el tono de confirmación de llamada en la placa exterior, extraiga el puente J4.

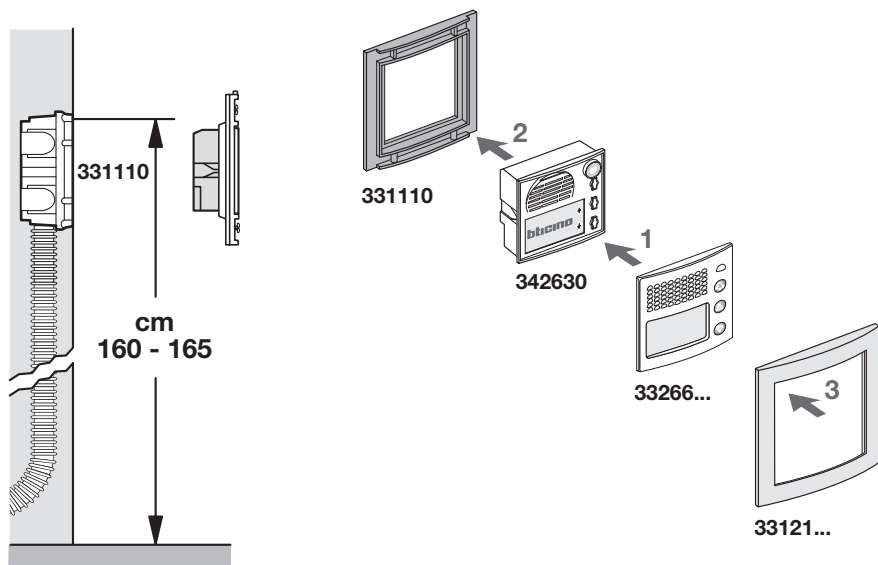
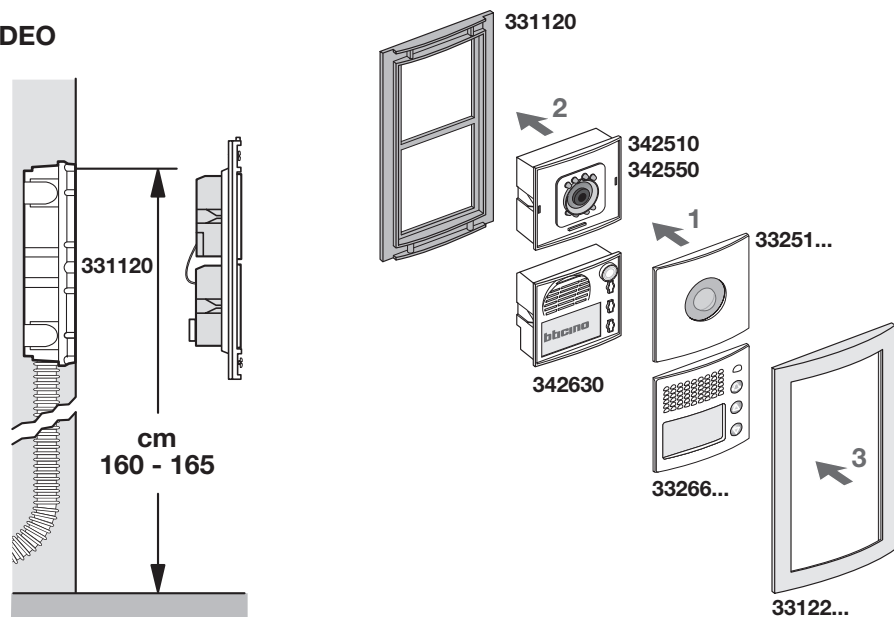
INSTALACIÓN**AUDIO****VIDEO**

INSTALACIÓN

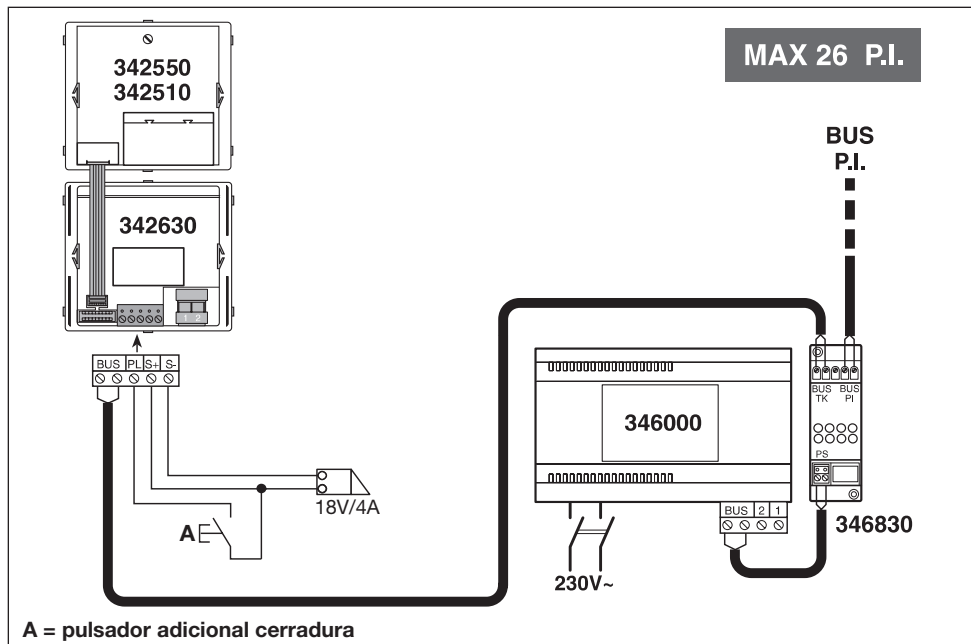
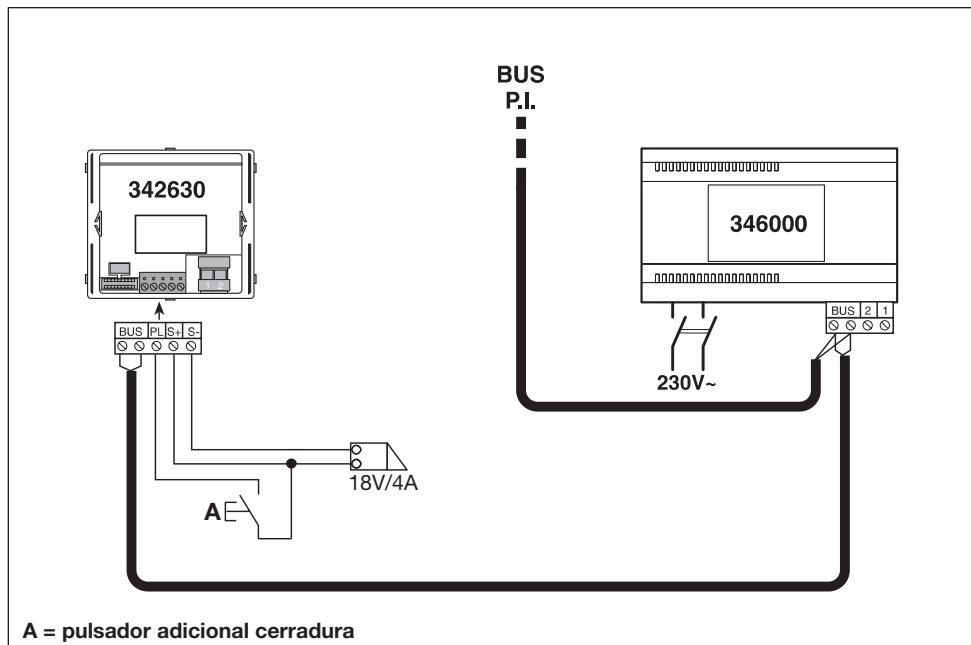

INSTALACIÓN

MAX 64 P.I.

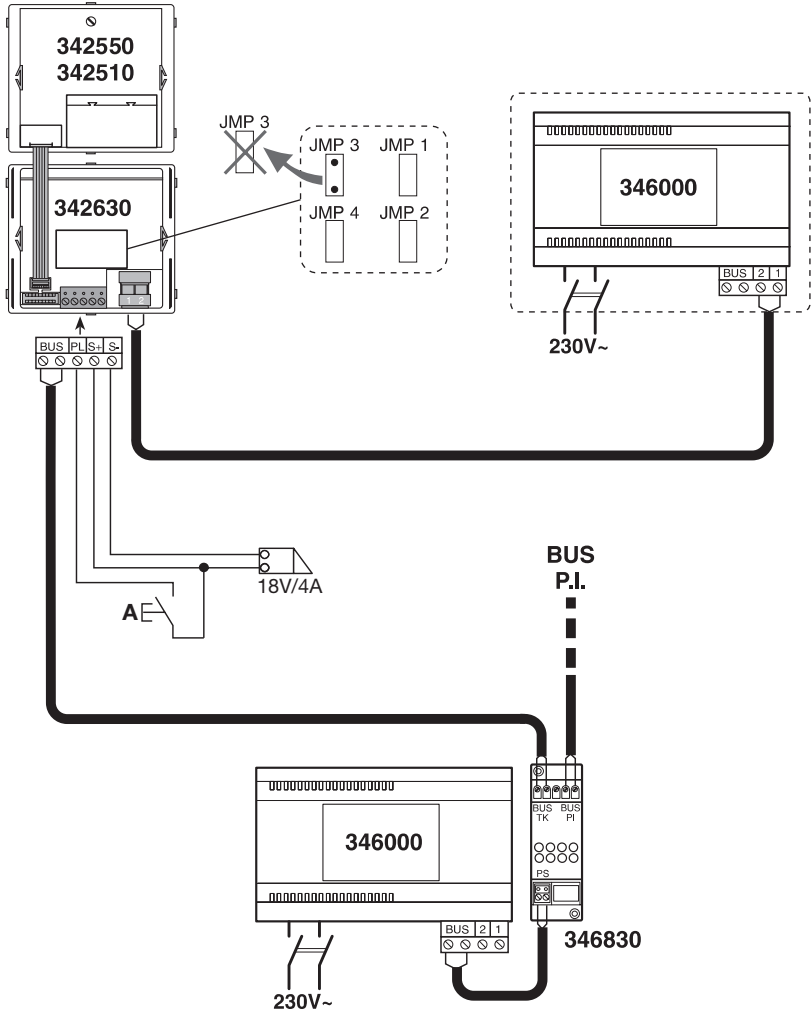

A = pulsador adicional cerradura



A series of horizontal dotted lines spanning the width of the page, providing a guide for handwriting practice.



BTicino s.p.a.
Via Messina, 38
20154 Milano - Italia
www.bticino.com