

• Dati dimensionali

• Dimensional data

• Données dimensionnelles

• Datos dimensionales

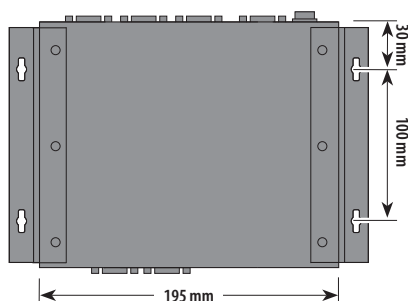
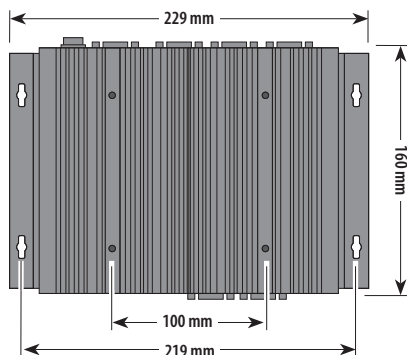
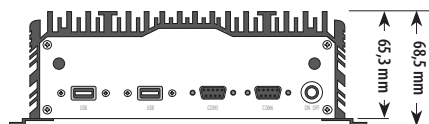

• Vista fronte e retro

• Front and rear view

• Vue frontale et postérieure

• Vista frontal y trasera

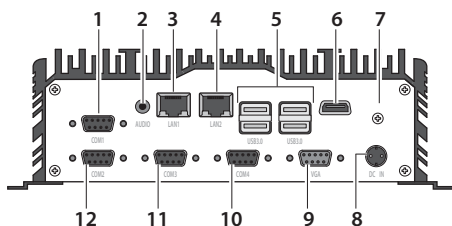

- | | |
|-----------------------------------|-------------------|
| 1. Ingresso COM1 | 9. Uscita VGA |
| 2. Uscita audio | 10. Ingresso COM2 |
| 3. Ingresso LAN 1 | 11. Ingresso COM3 |
| 4. Ingresso LAN 2 | 12. Ingresso COM4 |
| 5. Ingressi USB | 13. Power ON/OFF |
| 6. Uscita HDMI | 14. Ingresso COM5 |
| 7. Collegamento morsetto di terra | 15. Ingresso COM6 |
| 8. Ingresso DC | 16. Ingressi USB |

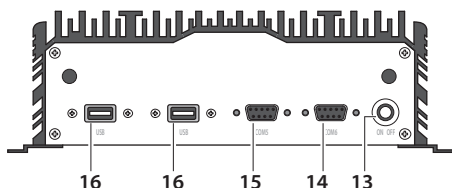

- | | |
|-------------------------------|------------------|
| 1. COM1 input | 9. VGA output |
| 2. Audio output | 10. COM2 input |
| 3. LAN 1 input | 11. COM3 input |
| 4. LAN 2 input | 12. COM4 input |
| 5. USB inputs | 13. Power ON/OFF |
| 6. HDMI output | 14. COM5 input |
| 7. Grounding clamp connection | 15. COM6 input |
| 8. DC input | 16. USB inputs |

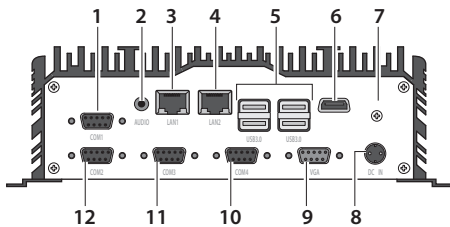

- | | |
|--------------------------------------------|----------------------|
| 1. Entrée COM1 | 9. Sortie VGA |
| 2. Sortie audio | 10. Entrée COM2 |
| 3. Entrée LAN 1 | 11. Entrée COM3 |
| 4. Entrée LAN 2 | 12. Entrée COM4 |
| 5. Entrées USB | 13. Puissance ON/OFF |
| 6. Sortie HDMI | 14. Entrée COM5 |
| 7. Branchement de la borne de mise à terre | 15. Entrée COM6 |
| 8. Entrée DC | 16. Entrées USB |

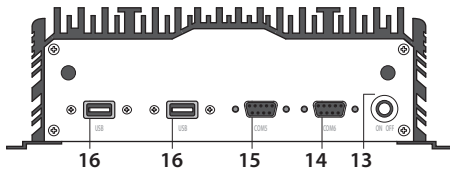

- | | |
|------------------------------------------|---------------------|
| 1. Entrada COM1 | 9. Salida VGA |
| 2. Salida audio | 10. Entrada COM2 |
| 3. Entrada LAN 1 | 11. Entrada COM3 |
| 4. Entrada LAN 2 | 12. Entrada COM4 |
| 5. Entrada USB | 13. Potencia ON/OFF |
| 6. Salida HDMI | 14. Entrada COM5 |
| 7. Conexión del borne de puesta a tierra | 15. Entrada COM6 |
| 8. Entrada DC | 16. Entrada USB |

• Dati tecnici server

CPU	Intel® i5 7287U Dual Core fino a 3,30 GHz 3M Cache
Consumo Energetico (TDP)	15 W
Memoria	8 G; 1 x DDR4 2133 Mhz
Archiviazione	512G; mSATA SSD
HDMI	Doppio Display: 1*HDMI+1*VGA
USB	6 x USB 3.0 (Type A)
Audio	1 x Audio
LAN	2 x Intel i211 10/100/1000 Mbps Ethernet
Temperatura di funzionamento	(- 10) – (+ 60) C°
Temperatura stoccaggio	(- 20) – (+ 75) C°
Dimensione (W x D x H)	190 x 160 x 65 mm
Peso	N.W. 1,95 Kg (4.3 lb)
Peso lordo	3,5 Kg
Materiale	Legia di Alluminio

• Dati tecnici alimentatore

Tensione	100 – 240 Vac
Tensione in uscita	19 Vdc
Potenza in uscita	65 W
Frequenza di funzionamento	50 / 60 Hz
Temperatura di funzionamento	0 – 60 °C
Massima umidità relativa	95 %

• Server technical data

CPU	Intel® i5 7287U Dual Core up to 3.30 GHz 3M Cache
Power Consumption (TDP)	15 W
Memory	8 G; 1 x DDR4 2133 Mhz
Storage	512G; mSATA SSD
HDMI	Dual Display: 1*HDMI+1*VGA
USB	6 x USB 3.0 (Type A)
Audio	1 x Audio
LAN	2 x Intel i211 10/100/1000 Mbps Ethernet
Operating Temperature	(- 10) – (+ 60) C°
Storage Temperature	(- 20) – (+ 75) C°
Dimension (W x D x H)	190 x 160 x 65 mm
Weight	N.W. 1.95 Kg (4.3 lb)
Gross weight	3.5 Kg
Material	Aluminum Alloy

• Power technical data

Voltage	100 – 240 Vac
Output voltage	19 Vdc
Output power	65 W
Operating frequency	50 / 60 Hz
Operating temperature	0 – 60 °C
Maximum relative humidity	95 %

• Données techniques serveur

CPU	Intel® i5 7287U Dual Core jusqu'à 3,30 GHz 3M Cache
Consommation d'énergie (TDP)	15 W
Mémoire	8 G; 1 x DDR4 2133 Mhz
Archivage	512G; mSATA SSD
HDMI	Double Écran : 1*HDMI+1*VGA
USB	6 x USB3.0 (Type A)
Audio	1 x Audio
LAN	2 x Intel i211 10/100/1000 Mbps Ethernet
Température de fonctionnement	(- 10) – (+ 60) °C
Température de stockage	(- 20) – (+ 75) °C
Dimensions (L x P x H)	190 x 160 x 65 mm
Poids	N.W. 1,95 Kg (4.3 lb)
Poids brut	3,5 Kg
Matériel	Alliage d'aluminium

• Données techniques alimentateur

Tension	100 – 240 Vac
Tension de sortie	19 Vdc
Tension en sortie	65 W
Fréquence de fonctionnement	50 / 60 Hz
Température de fonctionnement	0 – 60 °C
Humidité relative maximale	95 %

• Datos técnicos servidor

CPU	Intel® i5 7287U Dual Core hasta 3,30 GHz 3M Cache
Consumo Energético (TDP)	15 W
Memoria	8 G; 1 x DDR4 2133 Mhz
Archivo	512G; mSATA SSD
HDMI	Doble Pantalla: 1*HDMI+1*VGA
USB	6 x USB3.0 (Type A)
Audio	1 x Audio
LAN	2 x Intel i211 10/100/1000 Mbps Ethernet
Temperatura de funcionamiento	(- 10) – (+ 60) °C
Temperatura de almacenaje	(- 20) – (+ 75) °C
Dimensiones (L x P x A)	190 x 160 x 65 mm
Peso	N.W. 1,95 Kg (4.3 lb)
Peso bruto	3,5 Kg
Material	Alceación de aluminio

• Datos técnicos alimentador

Tensión	100 – 240 Vac
Tensión en salida	19 Vdc
Potencia en salida	65 W
Frecuencia de funcionamiento	50 / 60 Hz
Temperatura de funcionamiento	0 – 60 °C
Máxima humedad relativa	95 %

Avvertenze e diritti del consumatore



Leggere attentamente prima dell'uso e conservare per un riferimento futuro.

Divieto di toccare le unità con le mani bagnate.

Divieto di utilizzo di pulitori liquidi o aerosol.

Divieto di occludere le aperture di ventilazione.

Divieto di modificare i dispositivi.

Divieto di rimuovere parti di protezione dai dispositivi.

Divieto di esporre l'unità a stillycidio o a spruzzi d'acqua.

Divieto di installare le unità in prossimità di fonti di calore / freddo.

Divieto di installare le unità in prossimità di gas nocivi e polveri.

Divieto di fissaggio delle unità su superfici non adatte.



Pericolo di shock elettrico.

Rischio caduta dei dispositivi a causa di cedimento della superficie su cui sono installati o installazione inappropriata.

Togliere l'alimentazione prima di ogni intervento sull'impianto. L'azionamento da remoto può causare danni a persone o cose.

Attenzione: le operazioni di installazione, configurazione, messa in servizio e manutenzione devono essere effettuate esclusivamente da personale qualificato.

Assicurarsi che l'installazione a parete sia effettuata correttamente come da istruzioni installative.

Assicurarsi che l'installazione dell'unità sia conforme alle normative vigenti. Collegare i cavi di alimentazione secondo le indicazioni.

Per eventuali espansioni di impianto utilizzare solo gli articoli indicati nelle specifiche tecniche

Warnings and consumer rights



Read carefully before use and keep for future reference.

Touching the units with wet hands is forbidden.

Using liquid cleaners or aerosols is forbidden.

Blocking the ventilation openings is forbidden.

Modifying the devices is forbidden.

Removing protective parts from the devices is forbidden.

Exposing the unit to water drops or splashes is forbidden.

Installing the units near heat/cold sources is forbidden.

Installing the units near harmful gases and powders is forbidden.

Fastening the units on unsuitable surfaces is forbidden.



Danger of electrical shock.

Risk of devices falling because the surface on which they are installed collapses or inappropriate installation.

Switch the power supply OFF before any work on the system. Remote operation may cause damage to people or property.

Caution: Installation, configuration, starting-up and maintenance must be performed exclusively by qualified personnel.

Check that the wall installation has been carried out correctly according to the installation instructions.

Check that the unit installation complies with the standards in force.

Connect the power supply wires as indicated.

Use only the items indicated in the technical specifications for any system expansions.

Avertissements et droits du consommateur



Lire attentivement avant toute utilisation et installation de nos produits et conserver pour toute consultation en cas de besoin.

Interdiction de toucher les unités avec les mains mouillées.
Interdiction d'utiliser des produits de nettoyage liquides ou des aérosols.
Interdiction de boucher les ouvertures de ventilation.



Interdiction de modifier les dispositifs.
Interdiction de retirer les parties de protection des dispositifs.
Interdiction d'exposer l'unité à des sautements ou à des éclaboussures.
Interdiction d'installer les unités à proximité de sources de chaleur/froid.
Interdiction d'installer les unités à proximité de gaz nocifs et poudres/poussières.
Interdiction de fixer les unités sur des surfaces non appropriées.



Risque d'électrocution.



Risque de chute des dispositifs en cas de rupture de la surface sur laquelle ils sont installés ou mauvaise installation.

Couper l'alimentation avant toute intervention sur l'installation.
L'actionnement à distance peut causer des dommages corporels ou matériels.

Attention : les opérations d'installation, de configuration, de mise en service et d'entretien doivent être confiées à un personnel qualifié.
S'assurer que l'installation murale est correctement effectuée conformément aux instructions d'installation.



S'assurer que l'installation de l'unité est conforme aux normes en vigueur.
Brancher les câbles d'alimentation dans le respect des indications fournies.
Pour les éventuelles extensions de l'installation, utiliser uniquement les articles indiqués dans les caractéristiques techniques.

Advertencias y derechos del consumidor



Lea detenidamente antes del uso y conserve la documentación para consultas futuras.

Se prohíbe tocar las unidades con las manos mojadas.
Se prohíbe el uso de limpiadores líquidos o aerosoles.
Se prohíbe taponar las aperturas de ventilación.
Se prohíbe modificar los dispositivos.
Se prohíbe desmontar las partes de protección de los dispositivos.
Se prohíbe exponer la unidad a goteos o a chorros de agua.
Se prohíbe instalar las unidades cerca de fuentes de calor /frío.
Se prohíbe instalar las unidades cerca de gases nocivos y polvo.
Se prohíbe fijar las unidades en superficies no aptas.



Peligro de choque eléctrico



Riesgo de caída de los dispositivos por hundimiento de la superficie de montaje o instalación inadecuada.

Corte la alimentación antes de intervenir en el sistema.
El accionamiento a distancia puede causar daños a personas o cosas.

Atención: Las operaciones de instalación, configuración, puesta en servicio y mantenimiento han de ser efectuadas exclusivamente por personal cualificado.

Asegúrese de que la instalación se haya efectuado correctamente según las instrucciones de instalación.
Asegúrese de que la instalación de la unidad cumpla las normativas vigentes.
Conecte los cables de alimentación según las indicaciones.
Para posibles expansiones del sistema, use solamente los artículos indicados en las especificaciones técnicas.

• Configurazione

• Configuration

• Configuration

• Configuración

- Per la configurazione ed installazione del dispositivo e qualsiasi altra informazione fare riferimento alla documentazione scaricabile dal sito:
• For device configuration and installation and for any other information, refer to the documentation that can be downloaded from the website:
- Pour la configuration et l'installation du dispositif et pour toute autre information, faire référence à la documentation téléchargeable en se rendant sur le site:
• Para la configuración e instalación del dispositivo y para cualquier otra información, consultar la documentación que puede descargarse en el sitio:



www.homesystems-legrandgroup.com

Hotel + Project



App



- ANDROID: Richiede Android 5.0 e successivo con accesso a Google Play
iOS: Richiede un iPhone o iPad con iOS 12.0 o successivo.
- ANDROID: requires Android 5.0 and higher with access to Google Play
iOS: requires an iPhone or iPad with iOS 12.0 or later
- ANDROID : Nécessite Android 5.0 ou suivant avec accès à Google Play
iOS : Nécessite un iPhone ou un iPad avec iOS 12.0 ou suivant.
- ANDROID: requiere Android 5.0 y sucesivo con acceso a Google Play
iOS: requiere el uso de un iPhone o iPad con iOS 12.0 o sucesivo

• Requisiti Win/Mac:

- spazio su disco 500MB
- scheda di rete wifi
- connessione internet
- webcam (per configurare dispositivi greenpower)
- sistemi operativi:
da Microsoft Windows® 10;
da macOS 10.15 Catalina.

• Win/Mac requirements:

- 500MB disk space
- Wi-Fi network card
- internet connection
- webcam (to configure greenpower devices)
- operating systems:
from Microsoft Windows® 10;
from macOS 10.15 Catalina.

• Pré-requis Win/Mac:

- 500 Mo d'espace disque
- carte de réseau wi-fi
- connexion Internet
- webcam (pour configurer les appareils greenpower)
- systèmes d'exploitation :
à partir de Microsoft Windows® 10;
à partir de macOS 10.15 Catalina.

• Requisitos Win/Mac:

- 500 MB de espacio en el disco
- tarjeta de red wi-fi
- conexión Internet
- cámara web (para configurar los dispositivos greenpower)
- sistemas operativos:
desde Microsoft Windows® 10;
desde macOS 10.15 Catalina.



- In caso di mancanza di alimentazione il dispositivo non funziona e non è raggiungibile, qualsiasi raccolta di dati personali viene interrotta.
- In case of power failure, the device does not work and cannot be reached, any collection of personal data is interrupted.
- En cas de coupure d'alimentation le dispositif ne fonctionne pas et n'est pas joignable, aussi toute collecte de données personnelles est interrompue.
- En caso de ausencia de alimentación, el dispositivo no funciona y no resulta accesible, quedando interrumpida cualquier recogida de datos personales.